

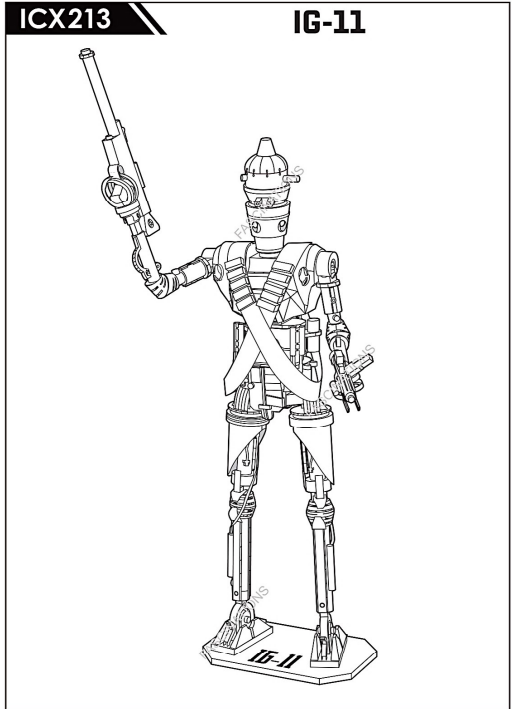

It is highly recommended that you visit www.metalearth.com/360/icx213 to see the completed model before assembling your own



TO CREATE THE BEST CONNECTIONS

Consider these engraved stripes as supporting features for the bend

Legends:

- E** Engraved/Color side
- NE** Non-engraved/Silver side
- Hand icon Attention point
- Blue dot Insert tab and bend 90 degrees
- Green triangle Insert tab and twist 90 degrees

Recommended tools:

- Wire cutters: helpful for taking parts from the metal sheets.
- Tweezers or needle nose pliers: helpful for folding parts, bending and twisting tabs.

Assembly tip:
If needed, slightly twist tabs to hold parts together then untwist and bend them down for a nice finish

METAL SHEETS

Parts with same color are duplicates

193, 163, 165, 42, 142, 191, 143, 139, 182, 181, 183, 177, 186, 185, 190, 184, 137, 150, 156, 71, 155, 176, 175, 174, 178, 147, 179, 136, 146, 164, 145

B

77, 45, 18, 47, 63, 16, 35, 29, 135, 57, 13, 52, 53, 10, 115, 62, 75, 39, 9, 24, 70, 33, 60, 98, 36, 12, 161, 5, 11, 2, 91, 23, 3, 27, 48, 21, 104, 40, 73, 14, 159, 92, 6

C

30, 15, 72, 34, 112, 88, 107, 17, 49, 100, 54, 78, 84, 97, 82, 4, 19, 46, 44, 94, 134, 61, 43, 55, 37, 110, 157, 81, 76, 111, 96, 108, 8, 105, 69, 51, 93, 28, 41, 1, 66, 80, 56, 65, 32, 20, 38, 59, 68, 64, 7, 113, 50, 83, 31

D

101, 160, 25, 192, 106, 194, 119, 37, 90, 67, 126, 167, 102, 122, 171, 149, 114, 172, 79, 173, 133, 26, 154, 153, 121, 131, 168, 99, 103, 151, 170, 74, 152, 22, 58, 166, 86, 130, 162, 116, 128, 123, 169, 124, 118, 127, 85, 125, 109, 158, 120, 89

! In order to avoid possible injury from sharp edges, please carefully discard the metal sheets after parts have been removed.

ASSEMBLY STEPS

Step 1

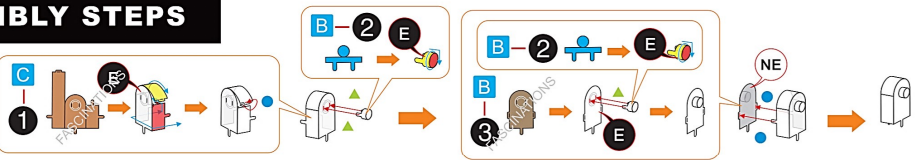

Step 2

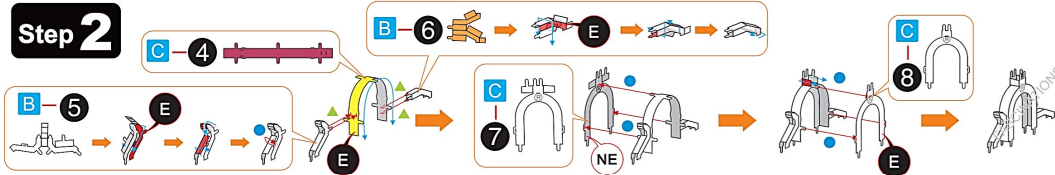

Step 3

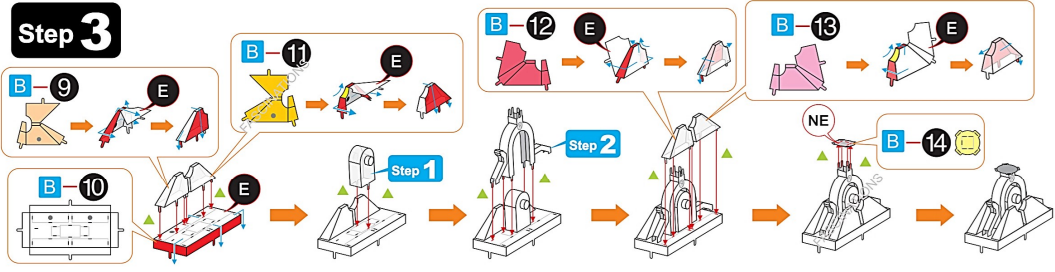

Step 4

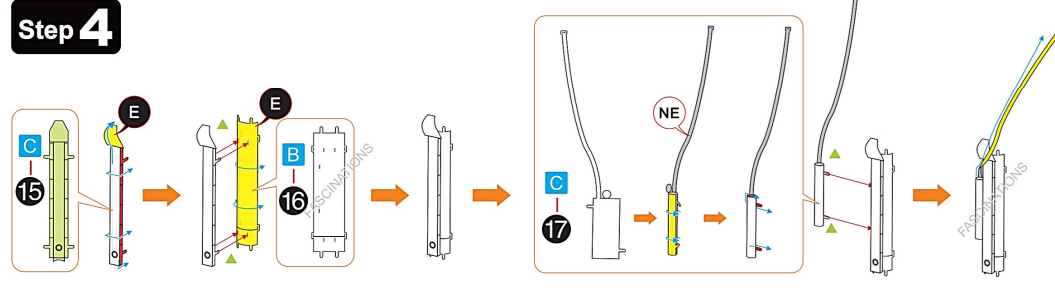

Step 5

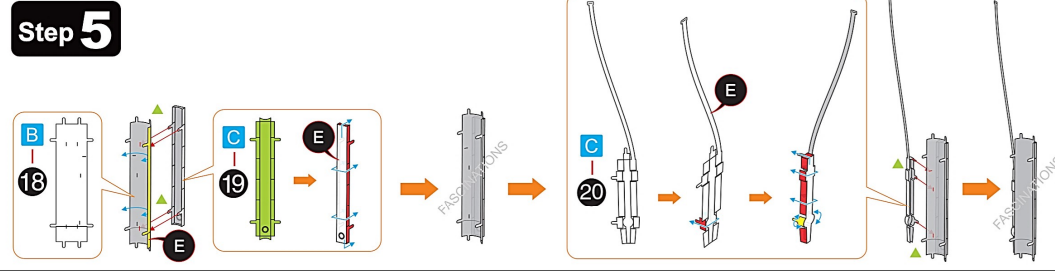

Step 6



Step 7

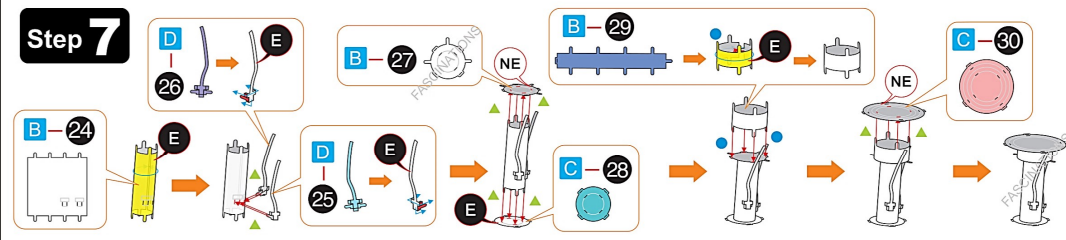

Step 8

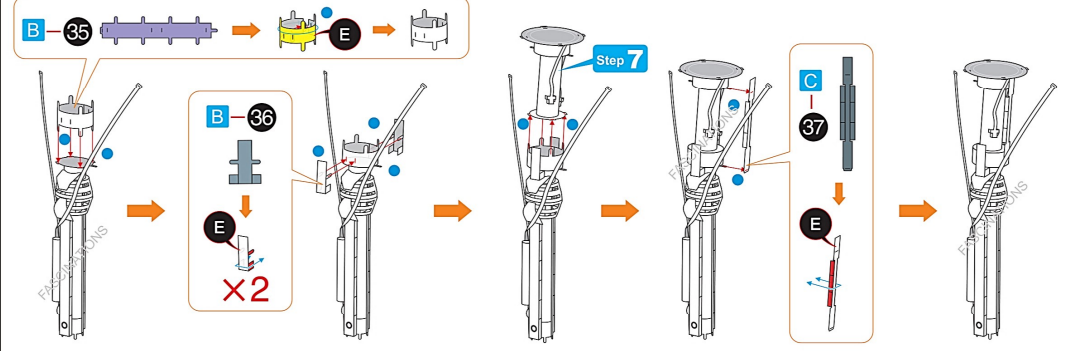
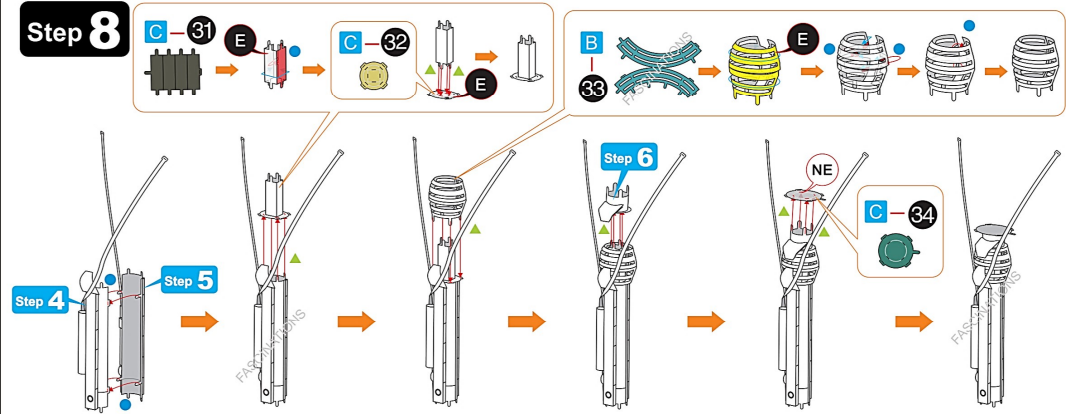

Step 9

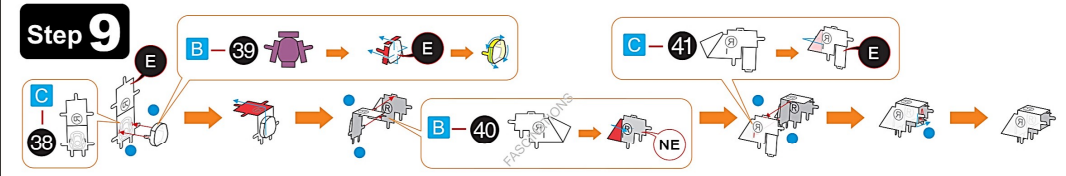

Step 10

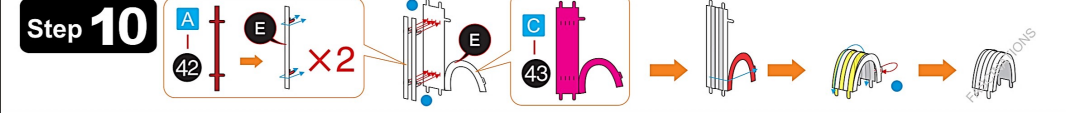

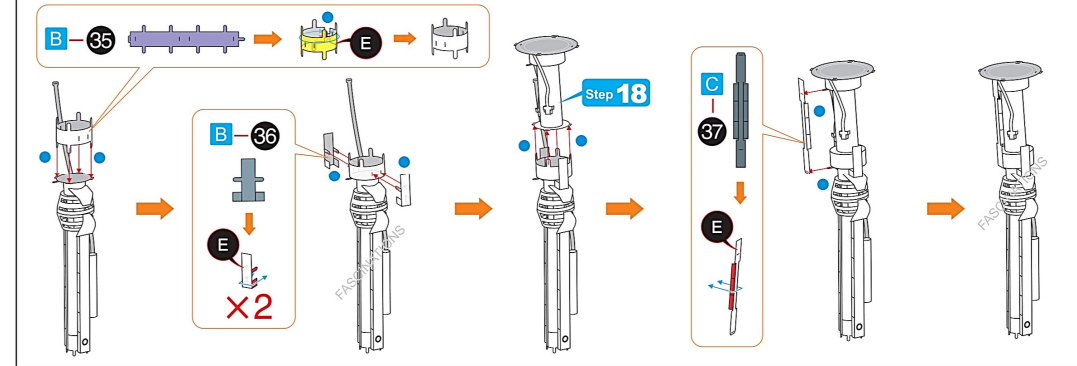
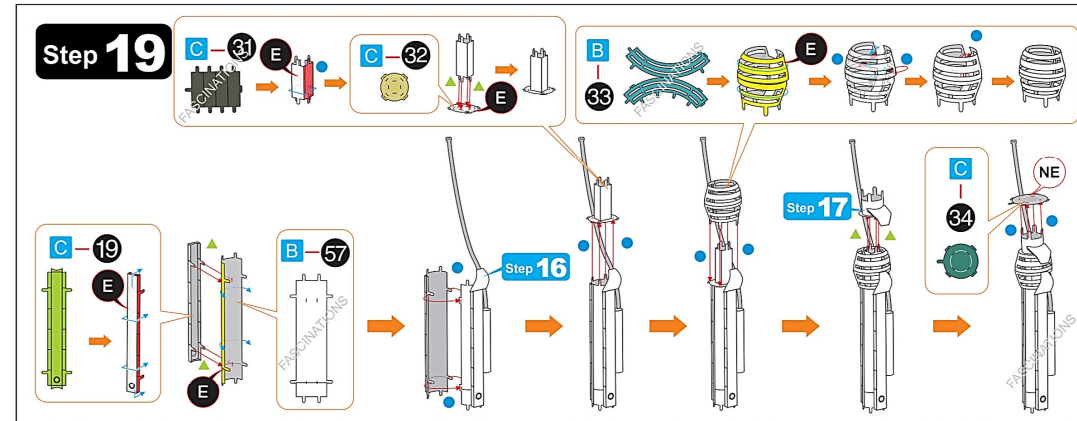
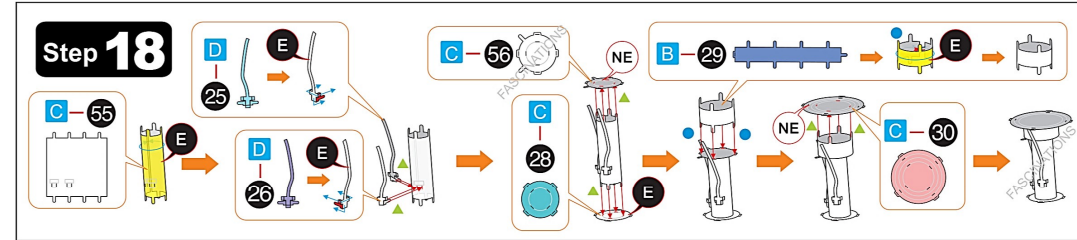
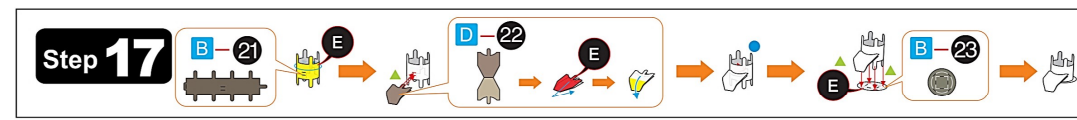
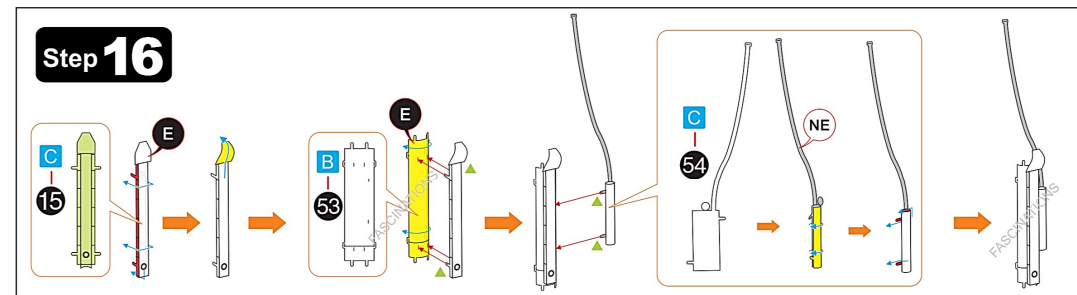
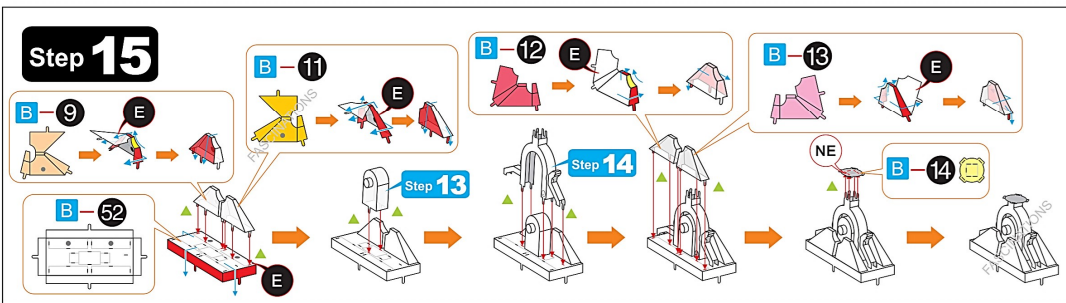
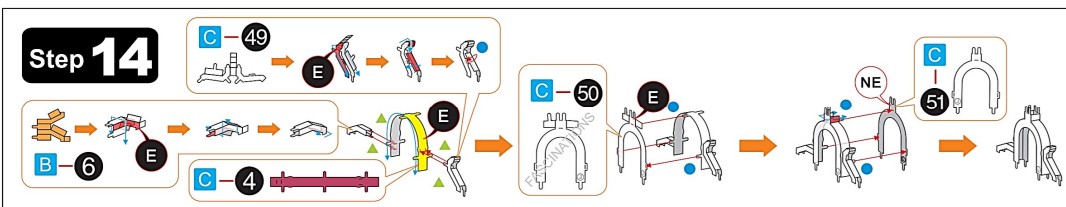
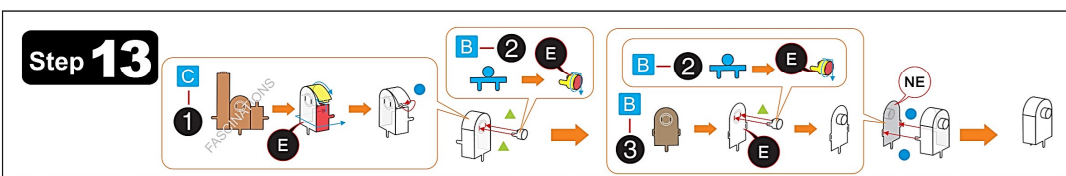
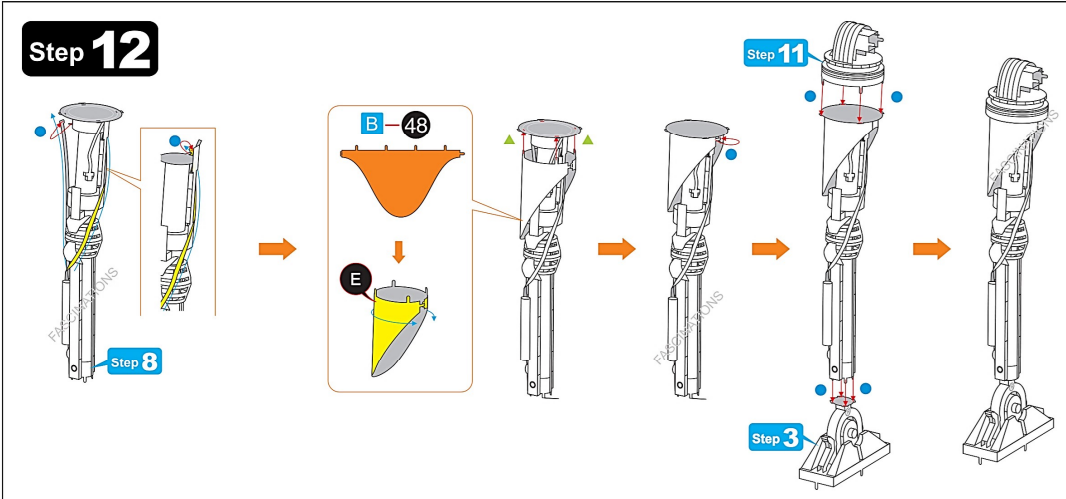
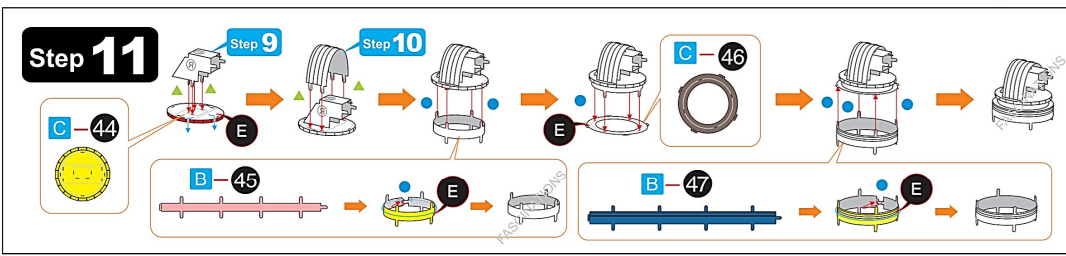

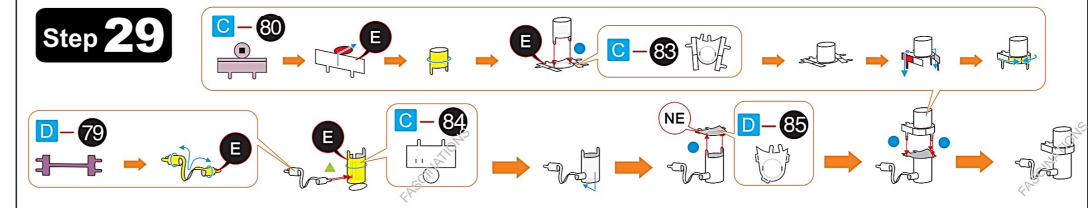
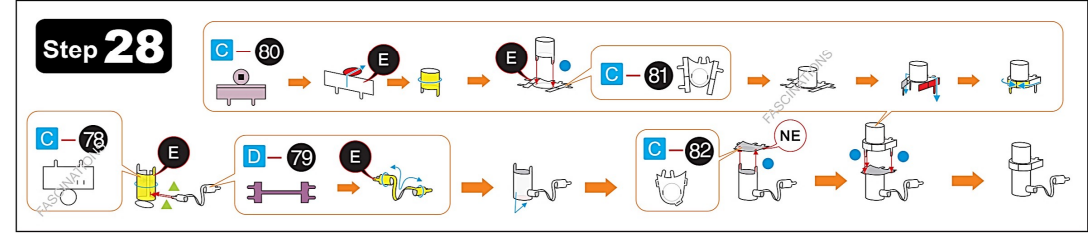
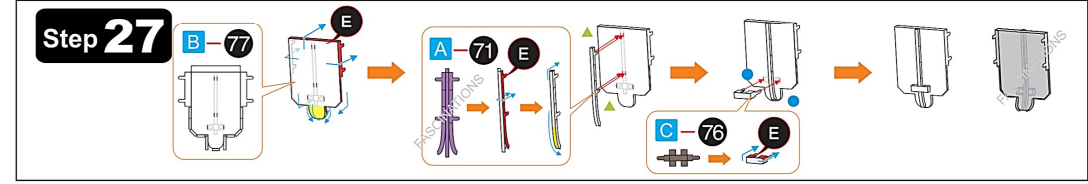
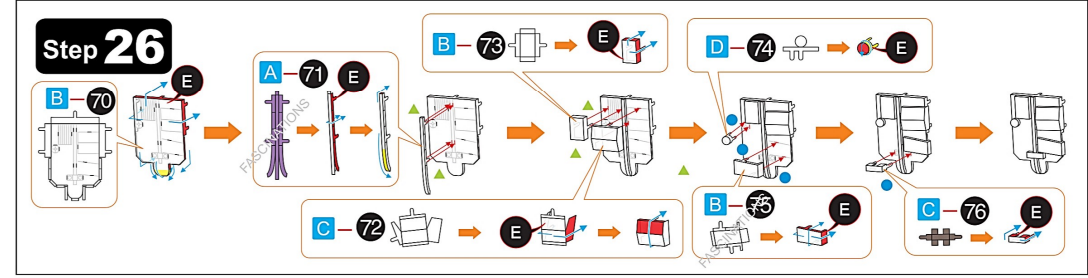
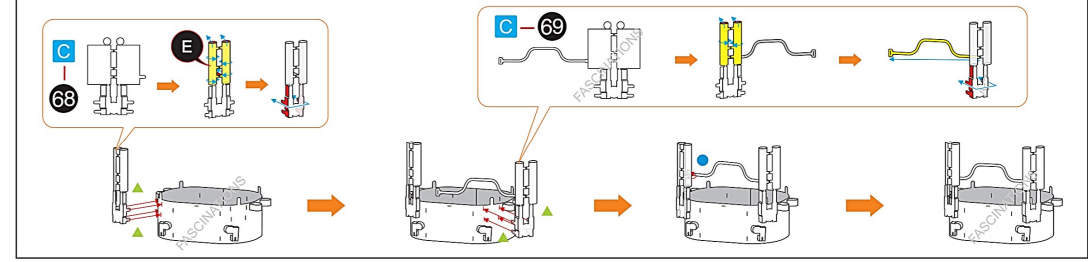
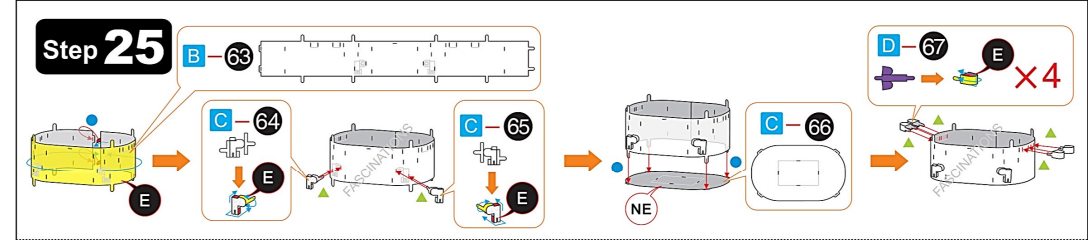
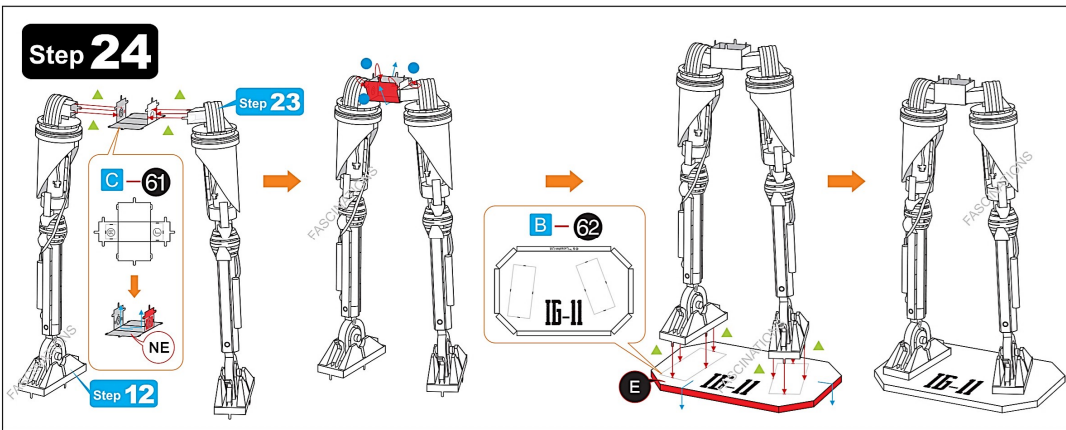
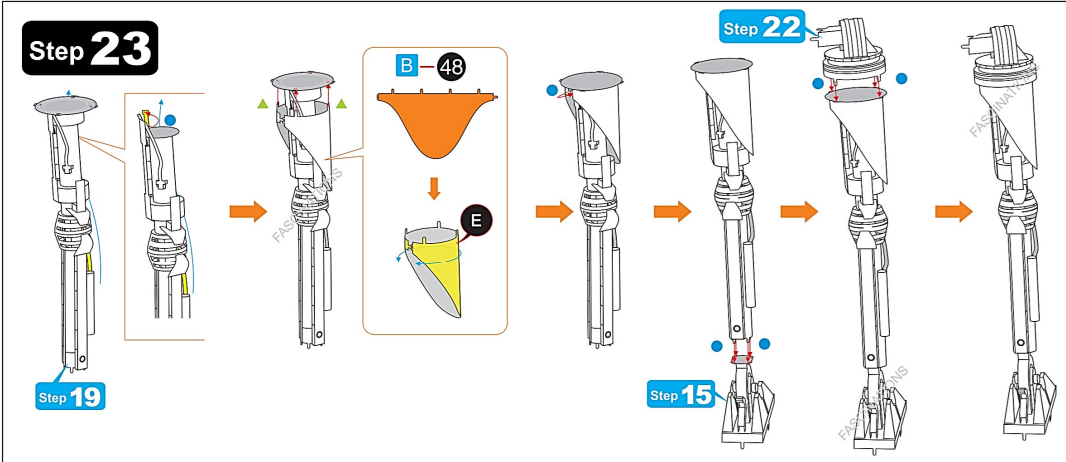
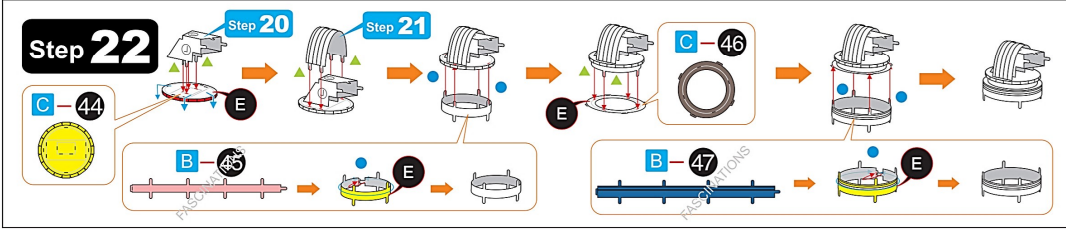
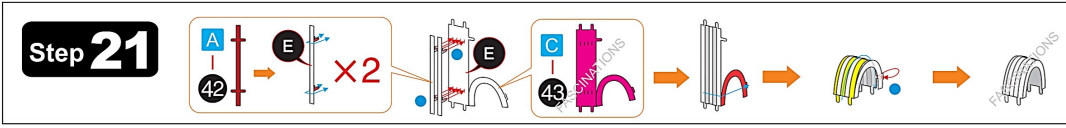
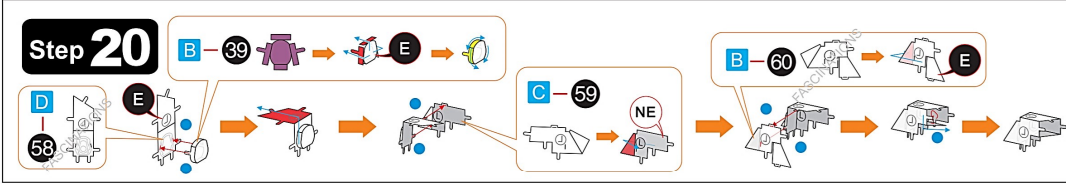

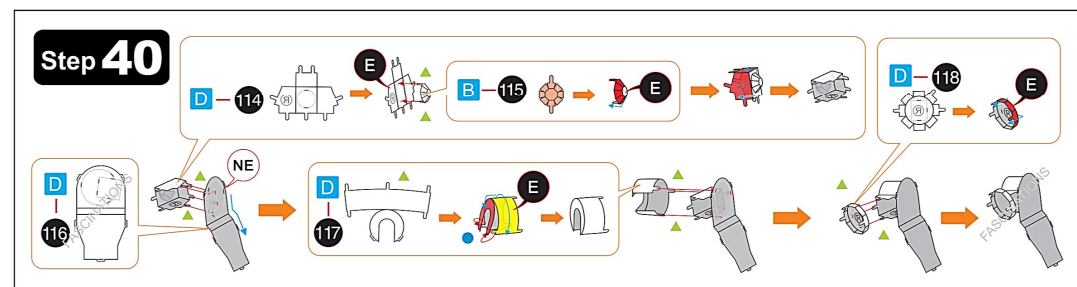
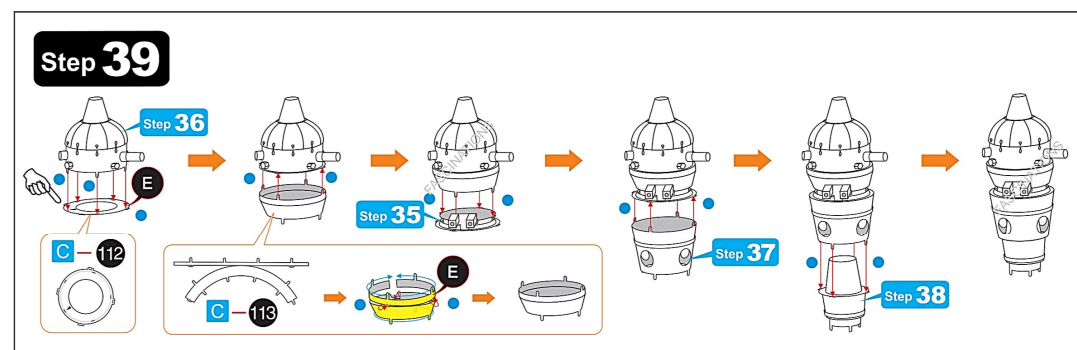
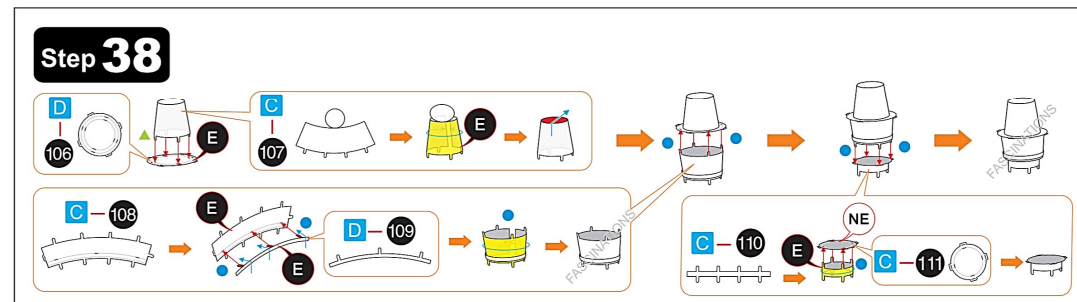
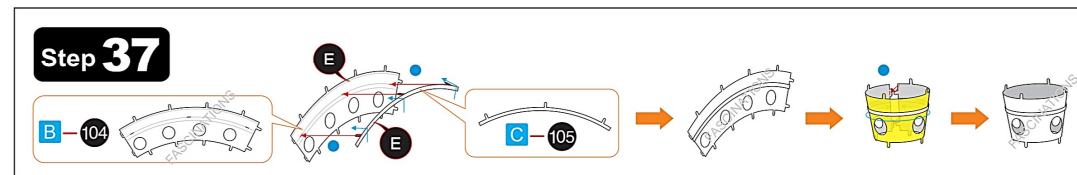
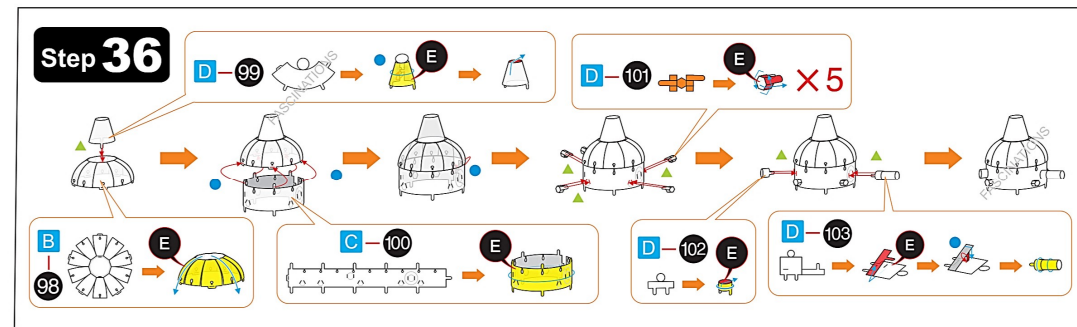
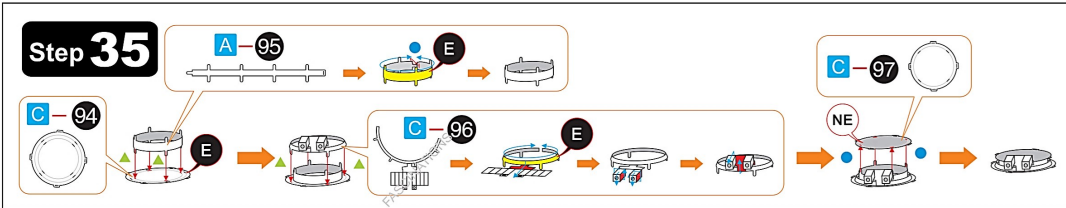
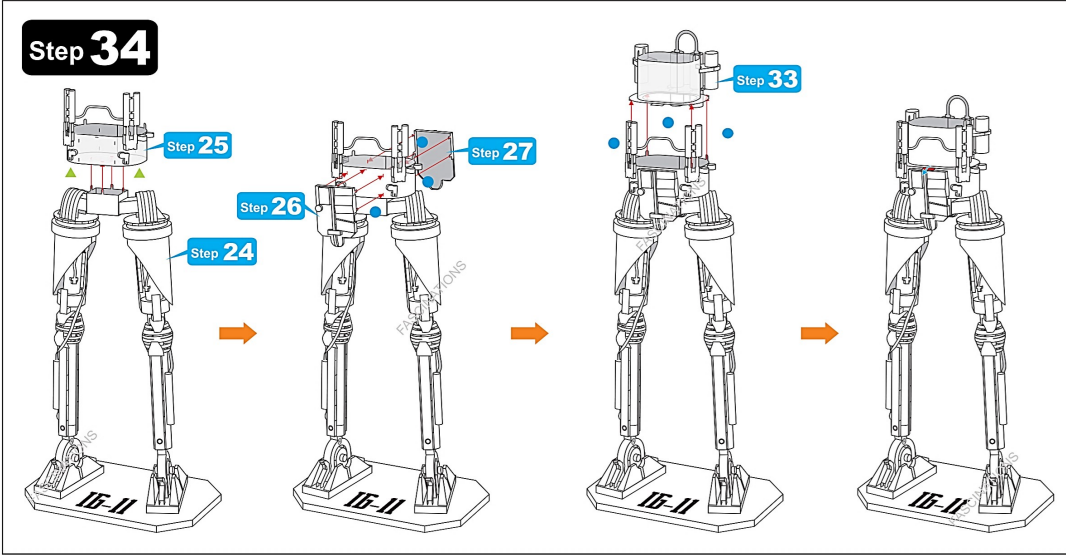
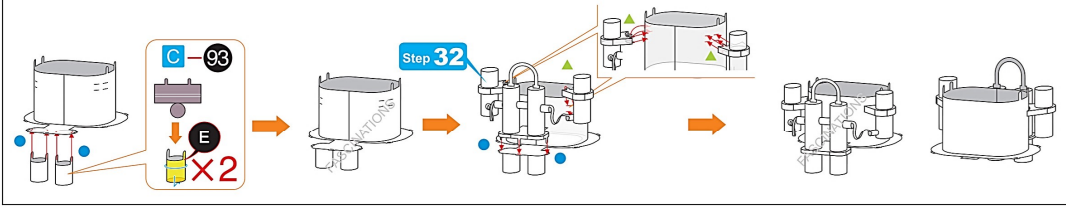
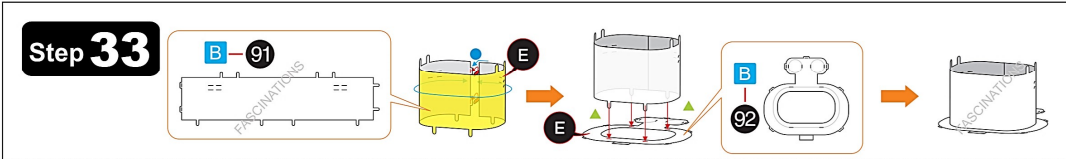
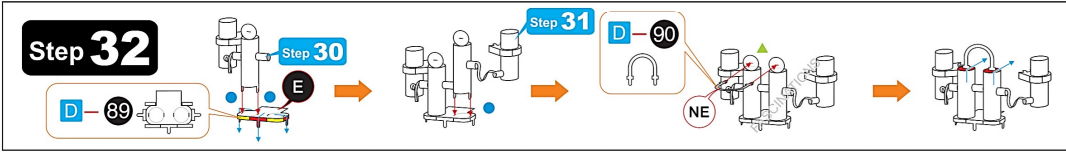
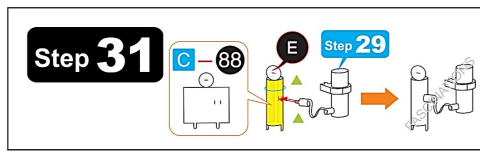
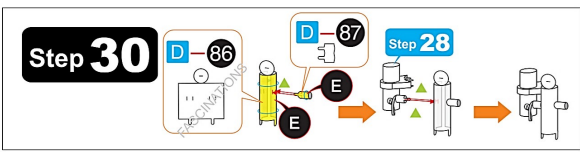

Step 41

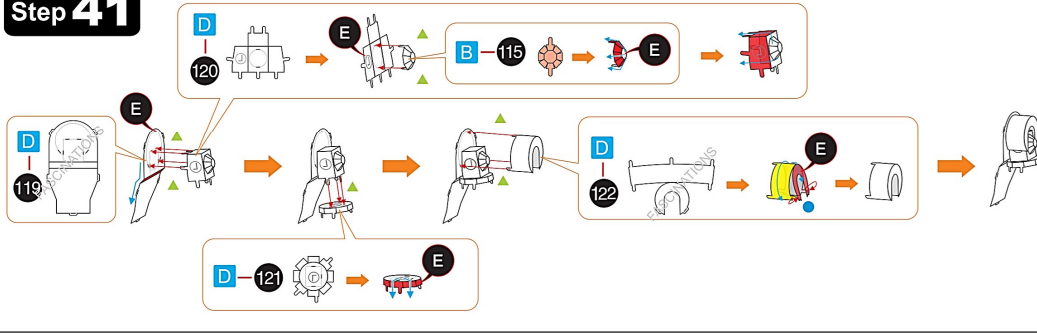

Step 42

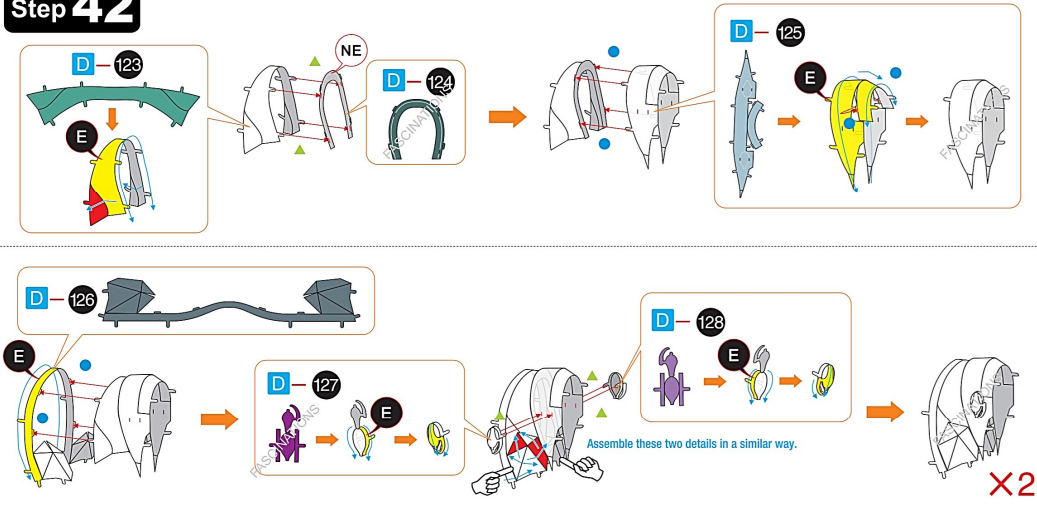

Step 43

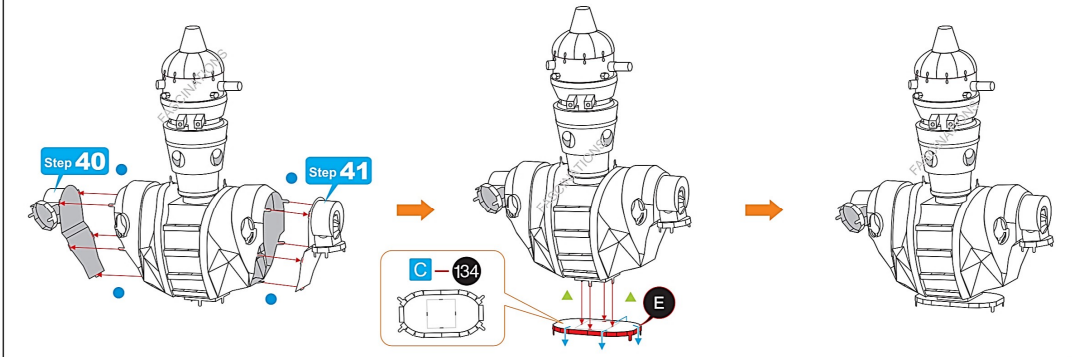
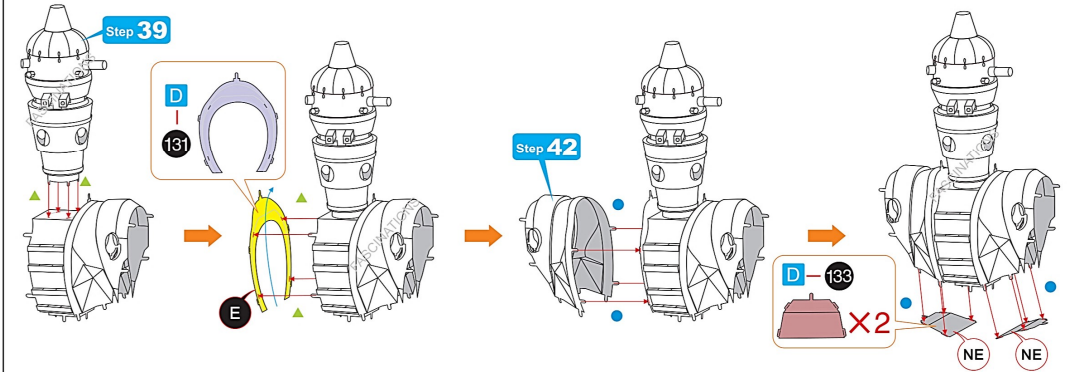
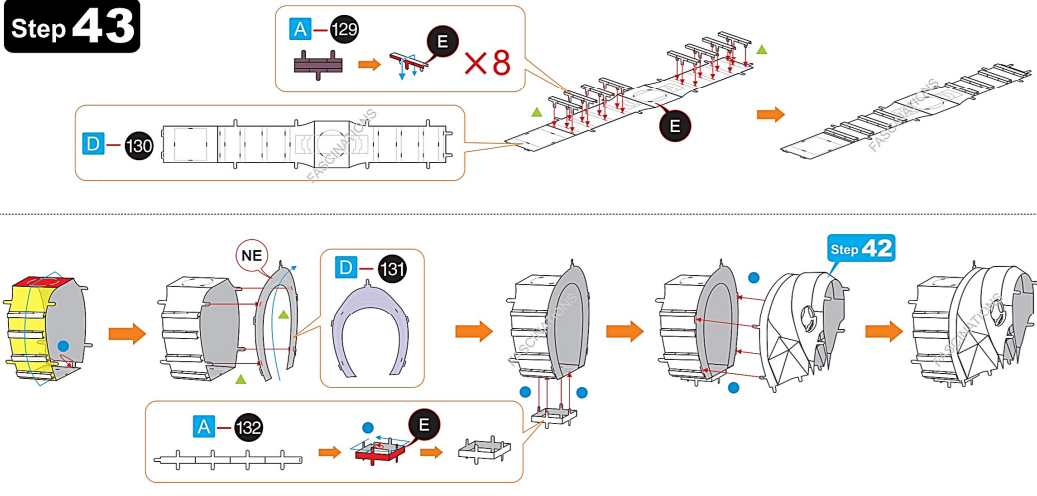

Step 44

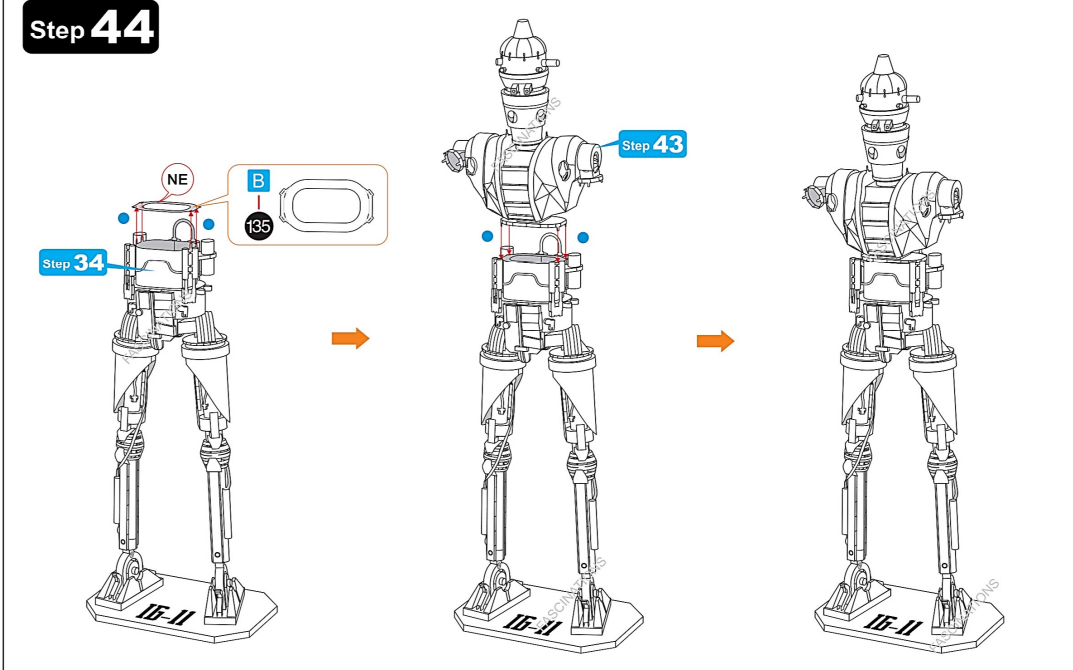

Step 45

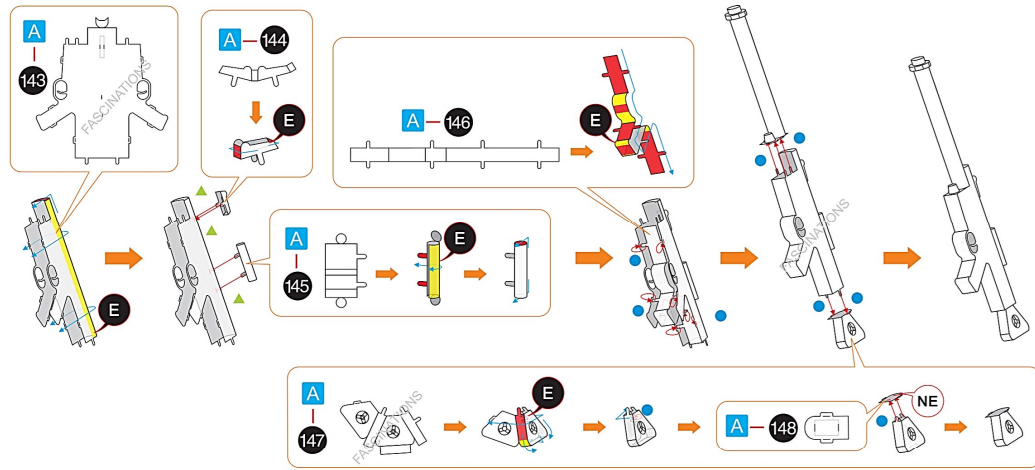
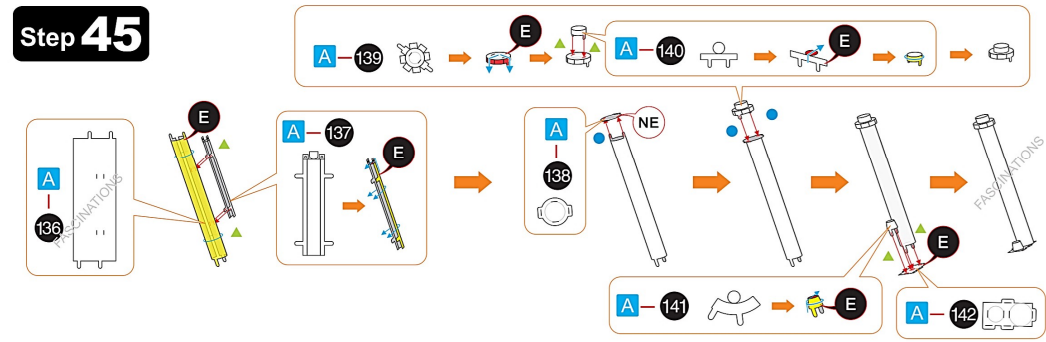

Step 46

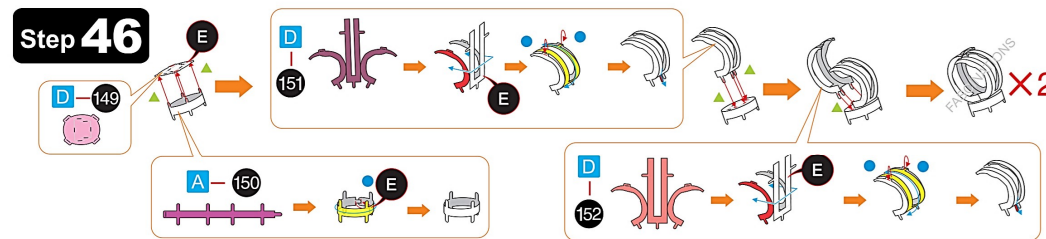

Step 47

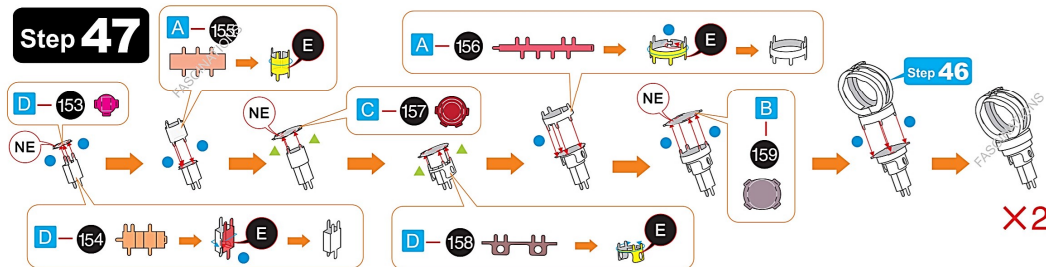

Step 48

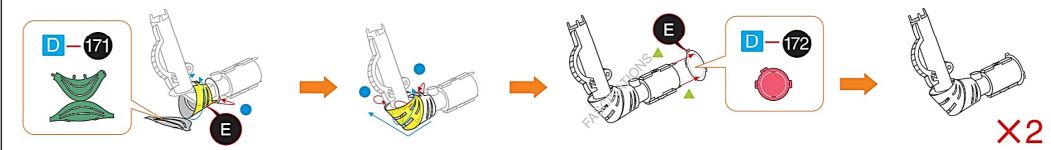
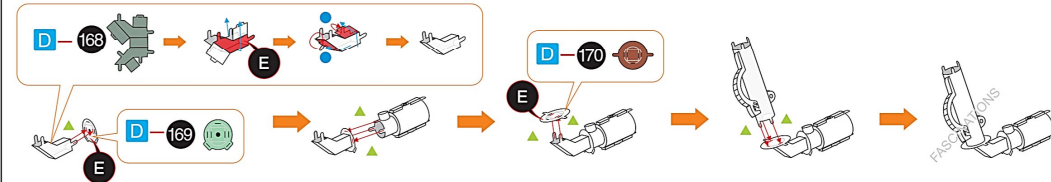
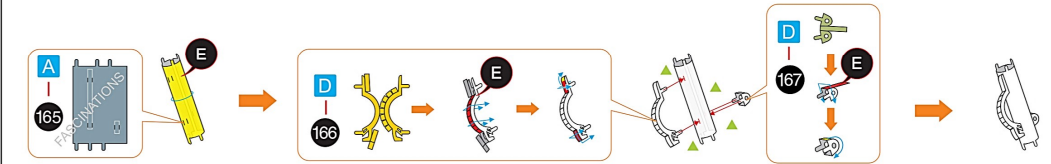
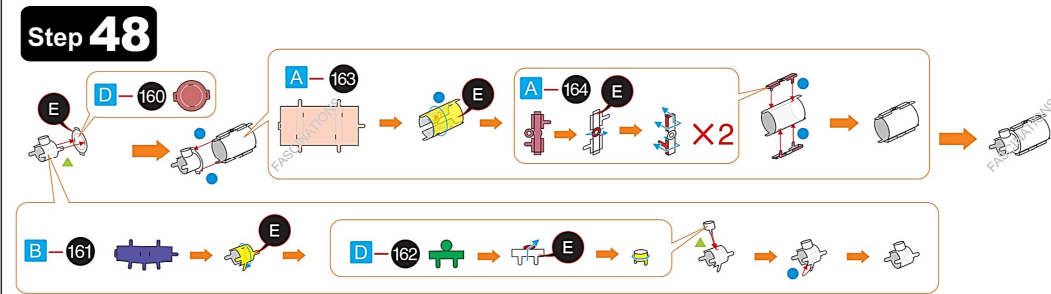

Step 49

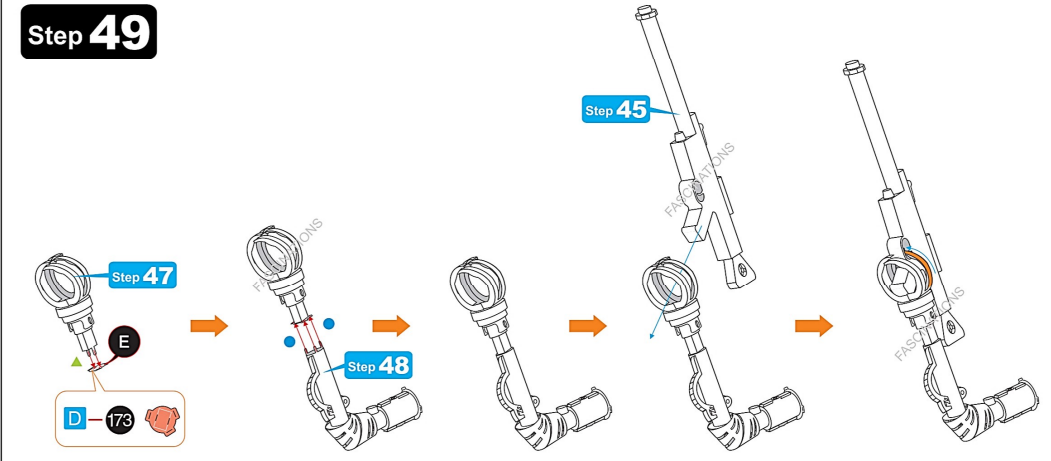

Step 50

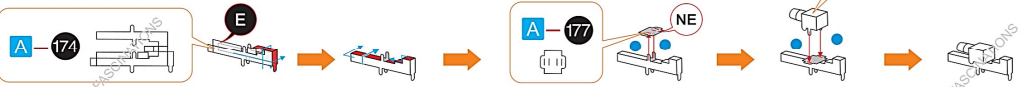
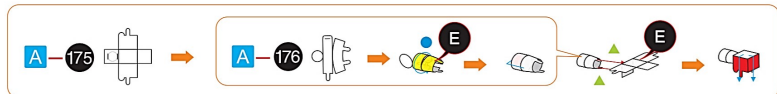

Step 51

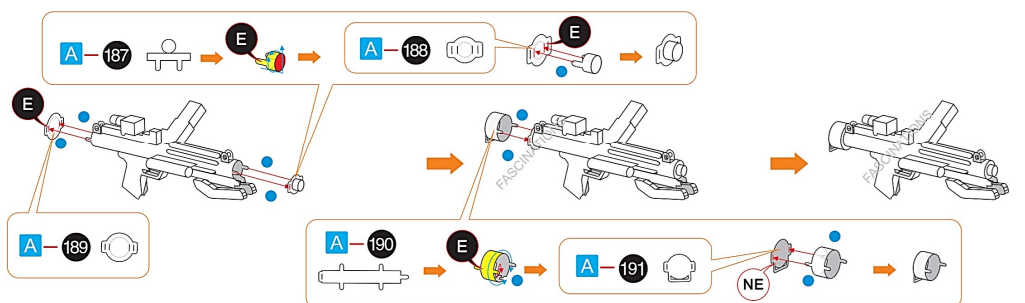
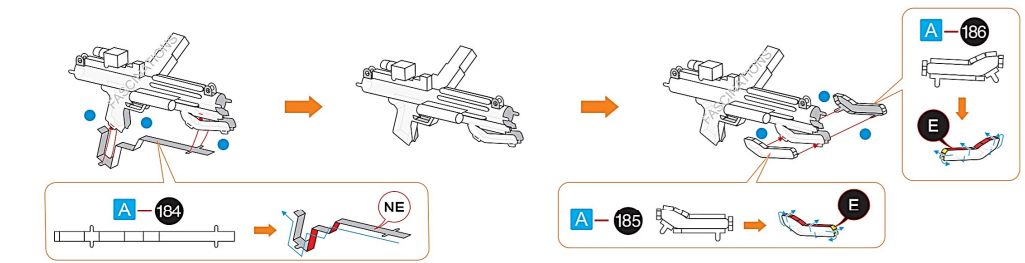
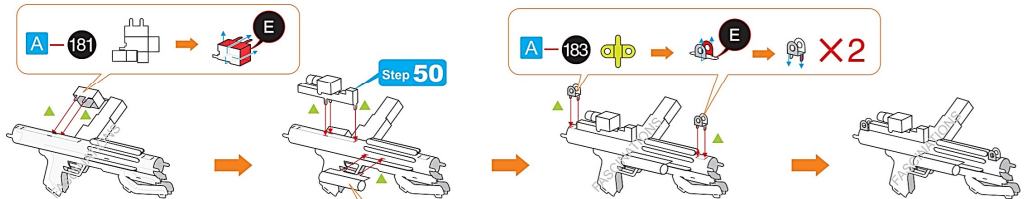
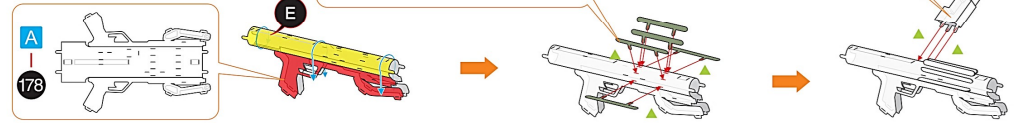

Step 52

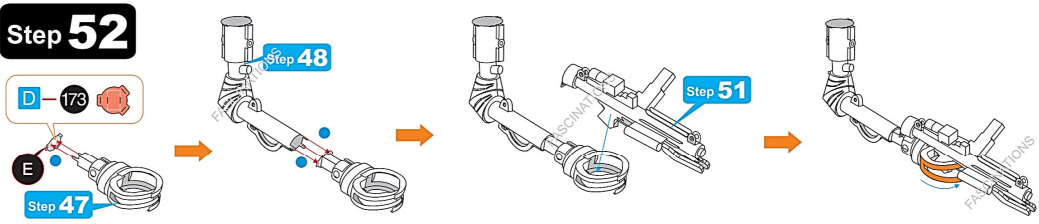

Step 53

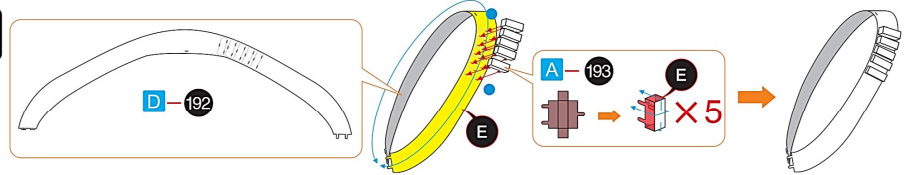

Step 54

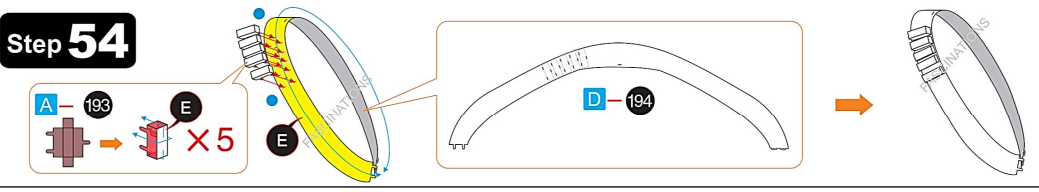

Step 55

