

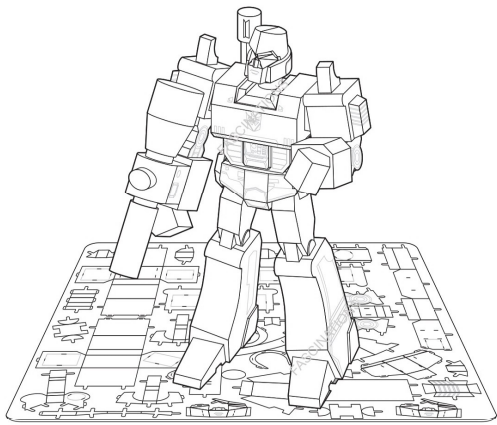

TRANSFORMERS and all related characters are trademarks of Hasbro and are used with permission. © 2022 Hasbro. All Rights Reserved. Licensed by Hasbro.



MEGATRON
MMS471



It is highly recommended that you visit www.metalearth.com/360/mms471 to see the completed model before assembling your own

METAL SHEETS

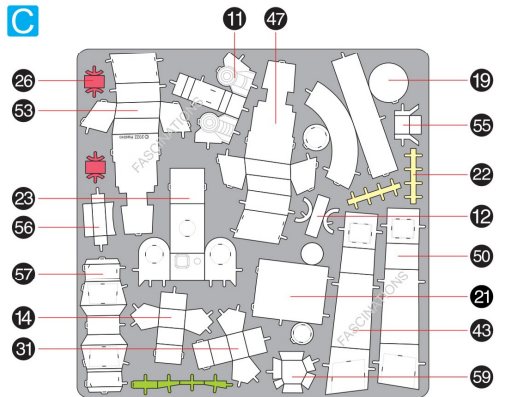
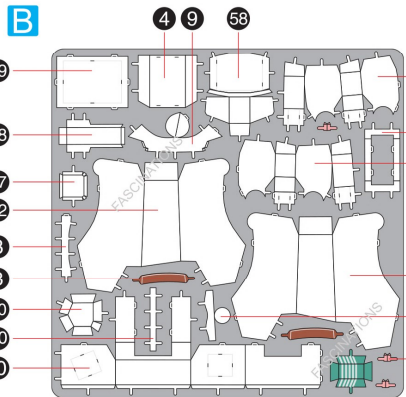
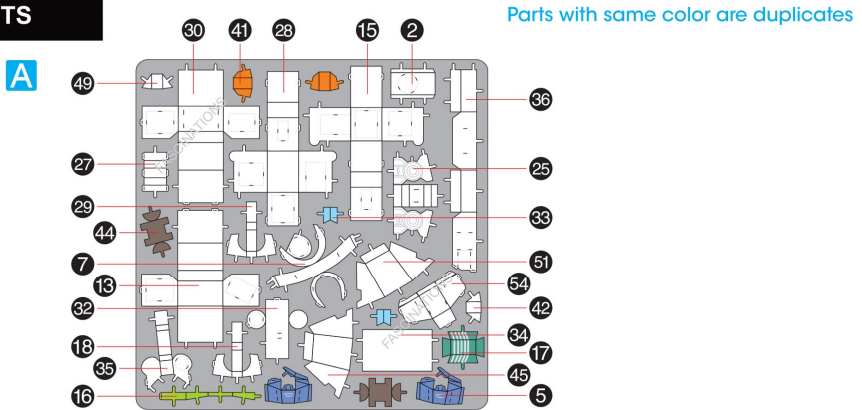

In order to avoid possible injury from sharp edges, please carefully discard the metal sheets after parts have been removed

TO CREATE THE BEST CONNECTIONS

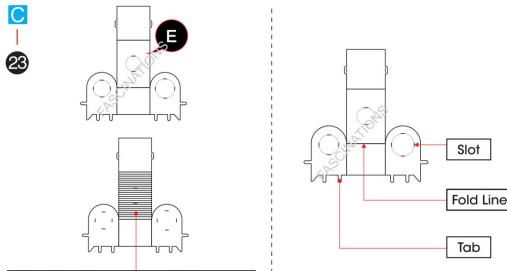

Consider these engraved stripes as supporting features for the bend

Legends:

- E** Engraved /Color side
- NE** Non-engraved /Silver side
- Attention point
- Insert tab and bend 90 degrees
- Insert tab and twist 90 degrees

Recommended tools:

-Wire cutters: helpful for taking parts from the metal sheets.



-Tweezers or needle nose pliers: helpful for folding parts, bending and twisting tabs.

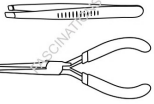

Assembly tip:

If needed, slightly twist tabs to hold parts together then untwist and bend them down for a nice finish

ASSEMBLY FLOW CHART

Step 1

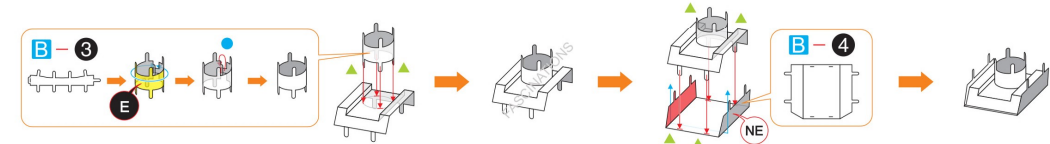
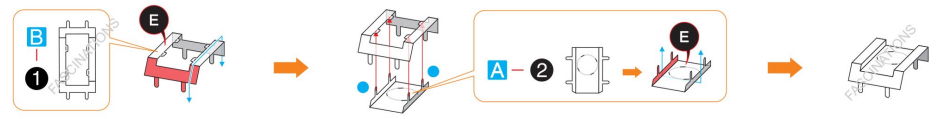

Step 2

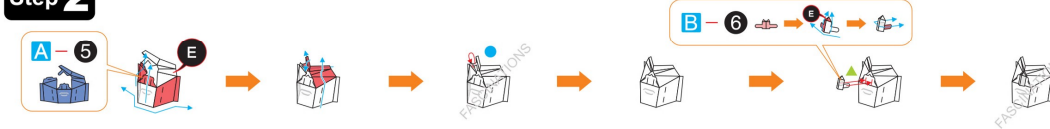

Step 3



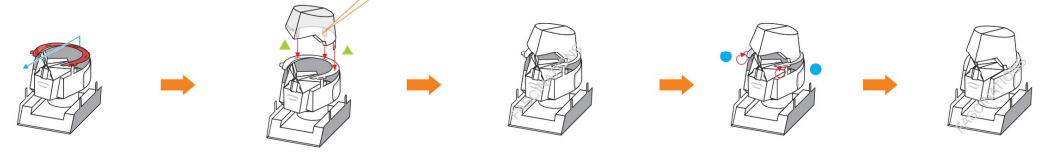
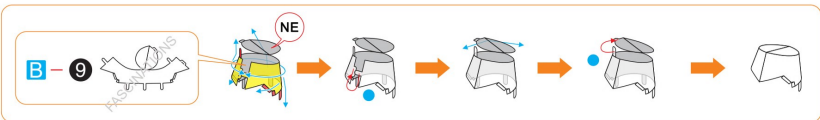

Step 4

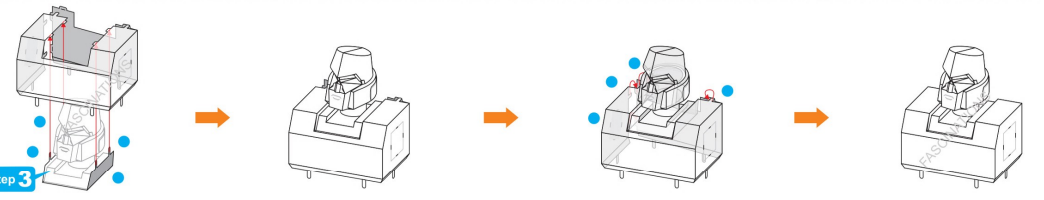
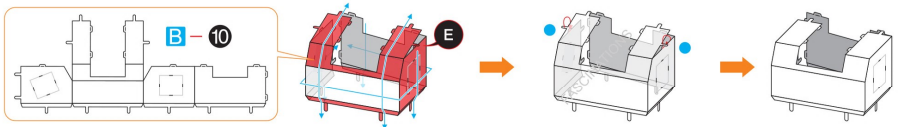

Step 5

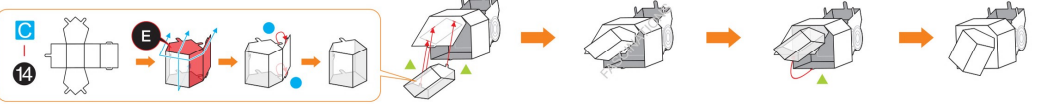
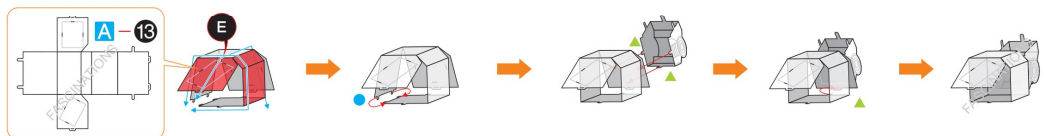
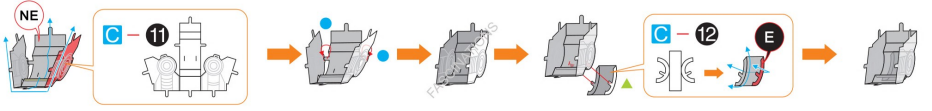

Step 6

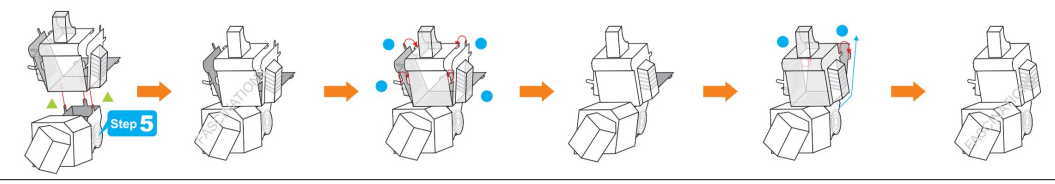
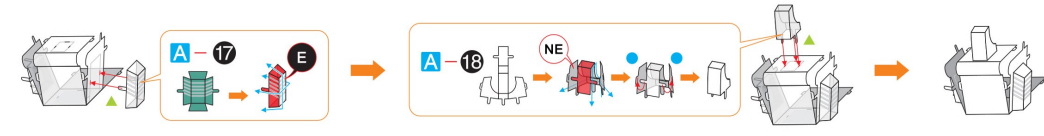
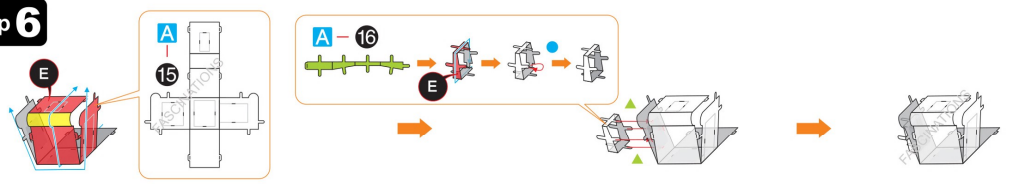

Step 7

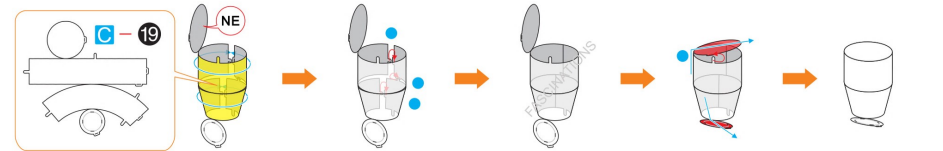

Step 8

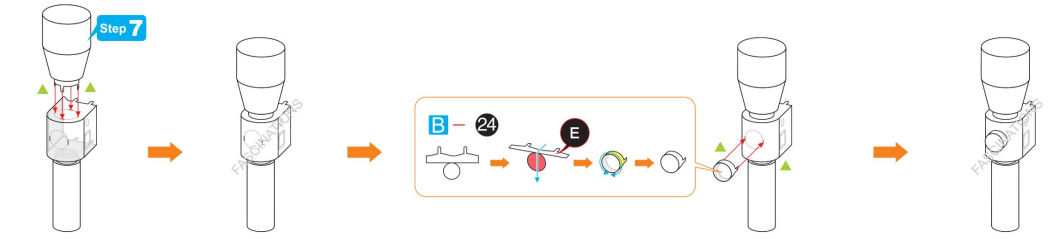
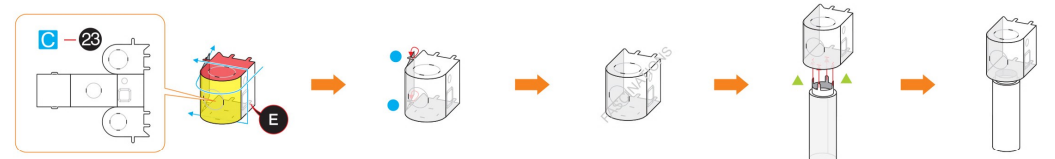
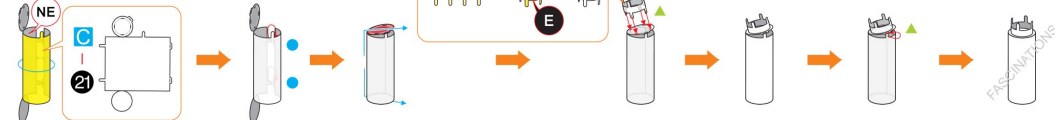

Step 9

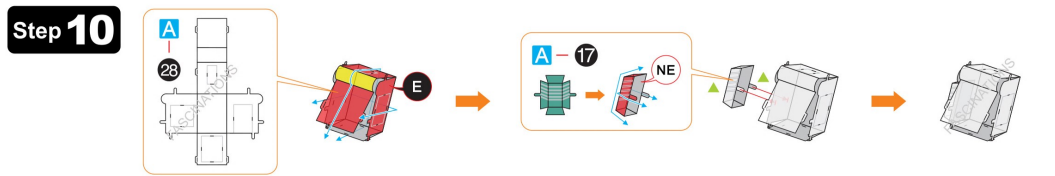
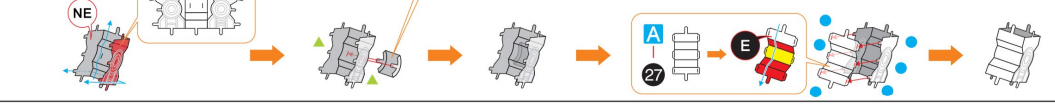

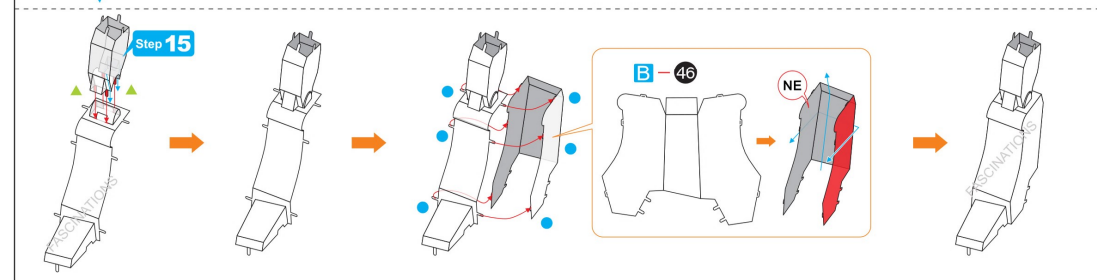
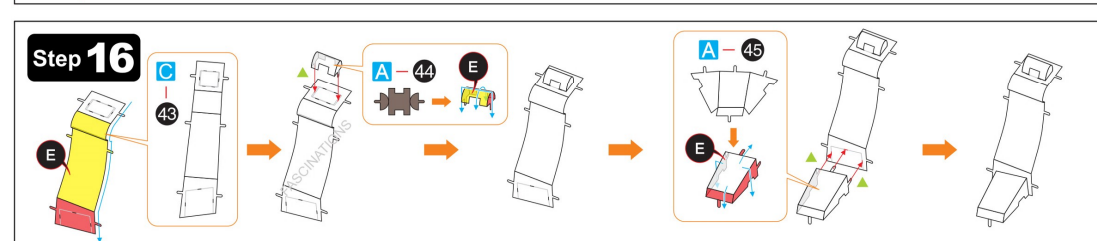
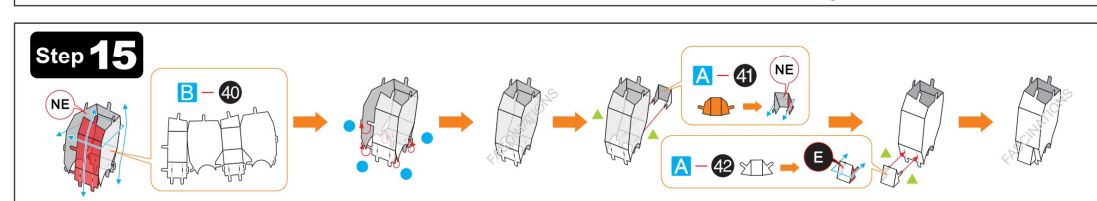
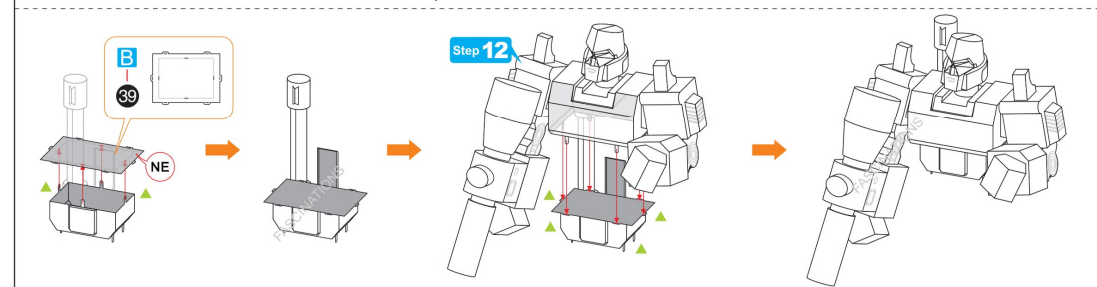
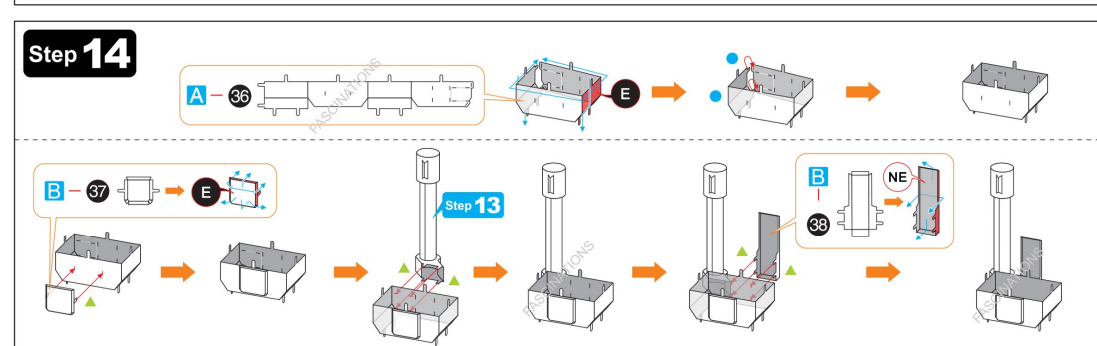
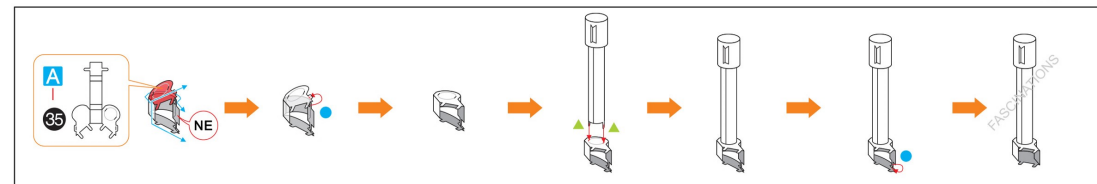
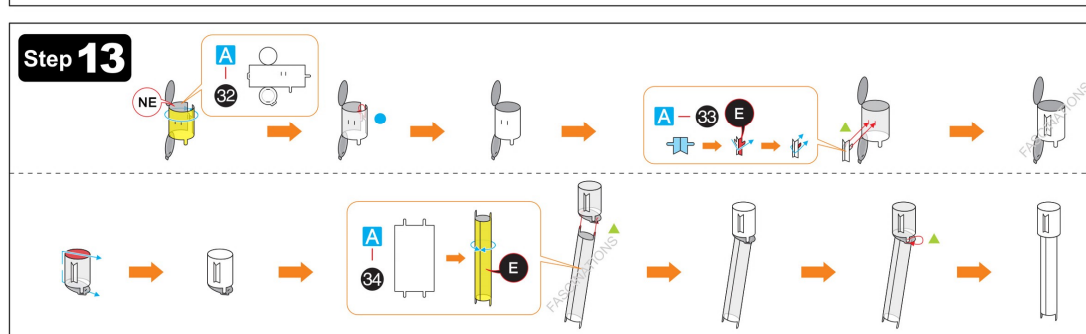
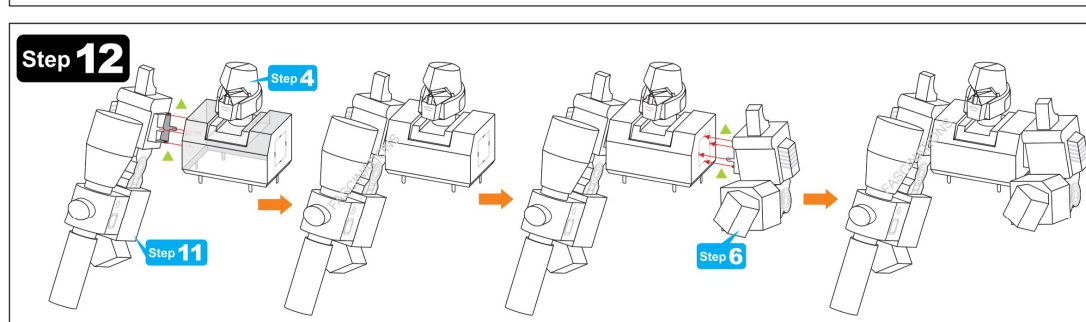
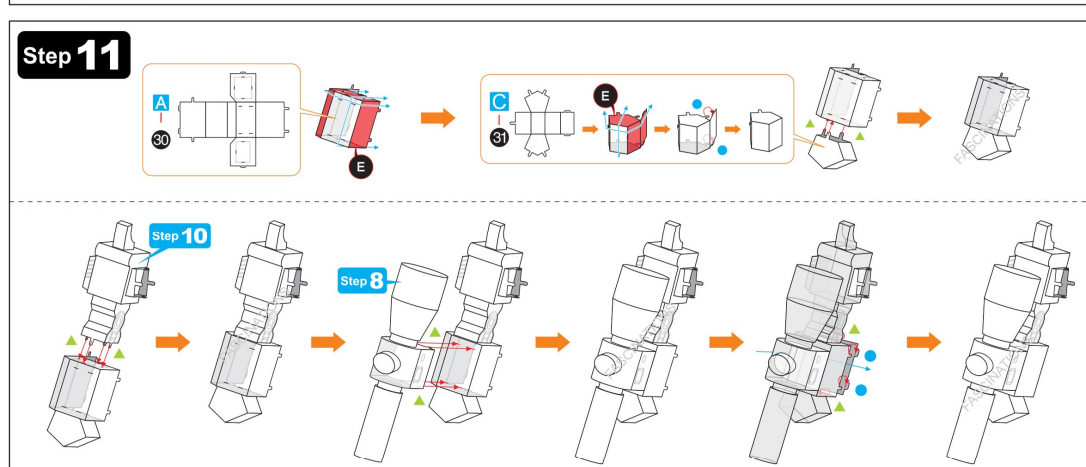
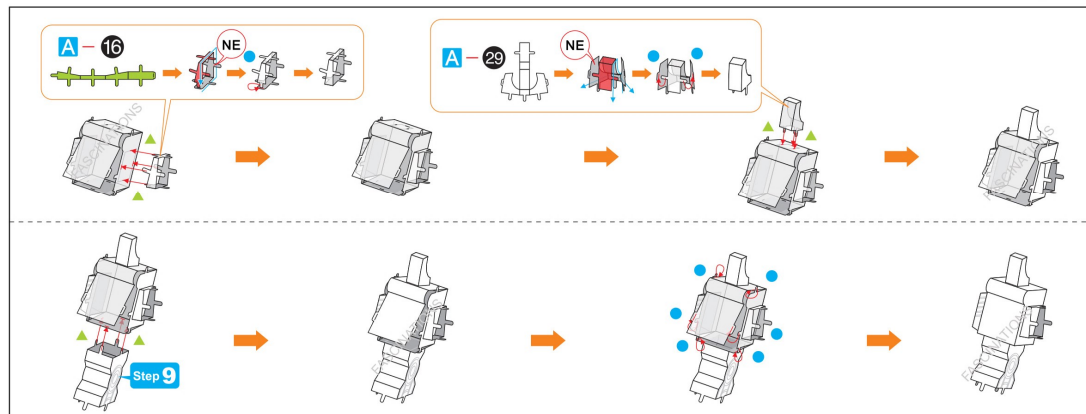

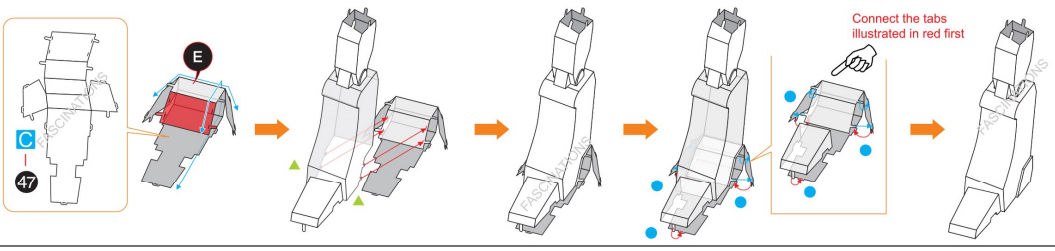

Step 17

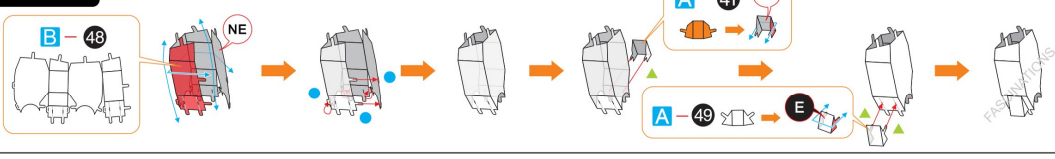

Step 18

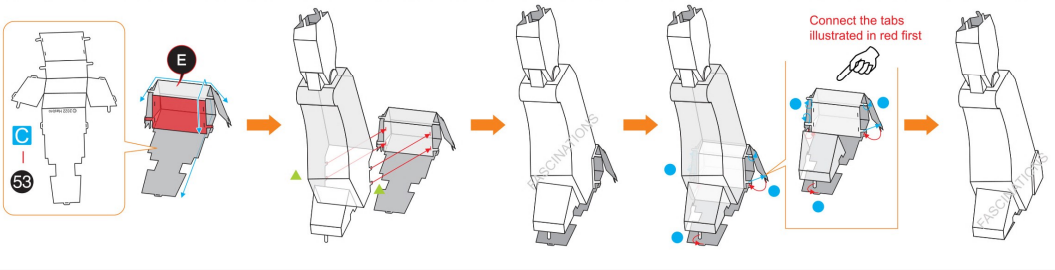
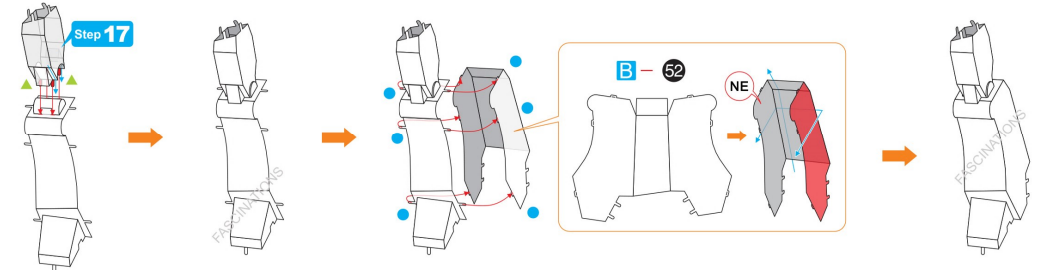
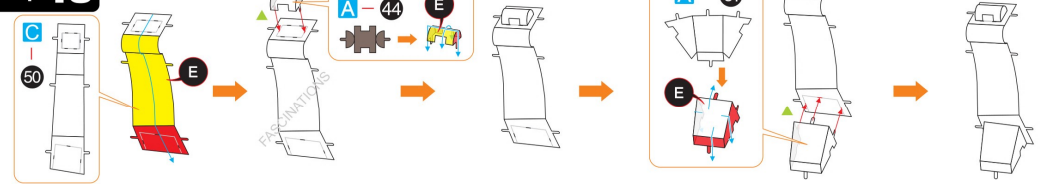

Step 19

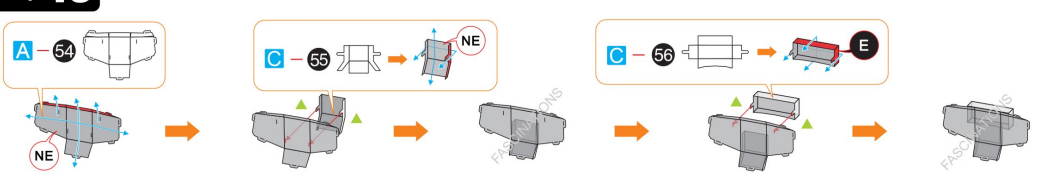

Step 20

