

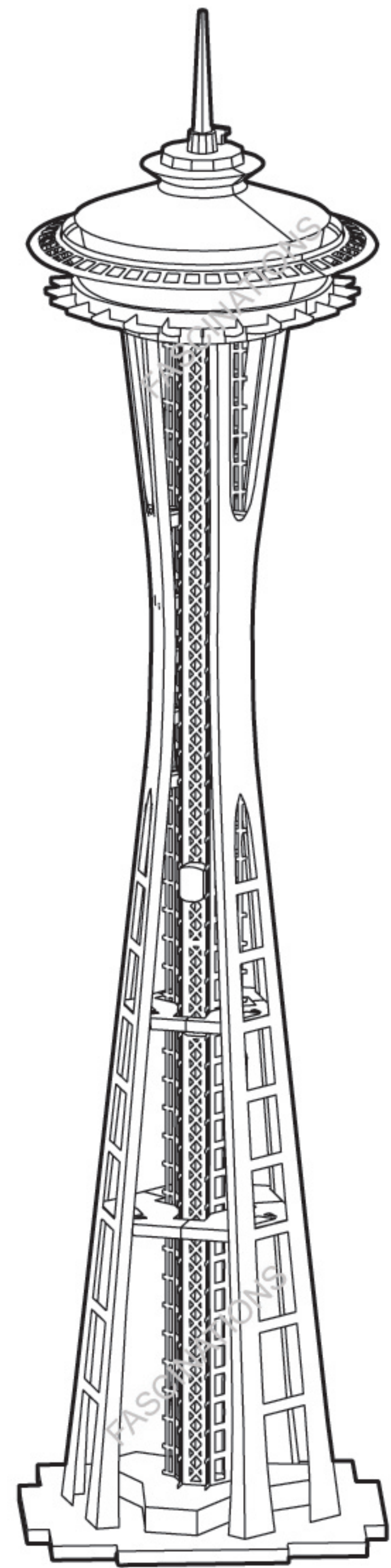

It is highly recommended that you visit www.metalearth.com/360/PS2010 to see the completed model before assembling your own

PS2010 1962 WORLD'S FAIR SPACE NEEDLE



TO CREATE THE BEST CONNECTIONS

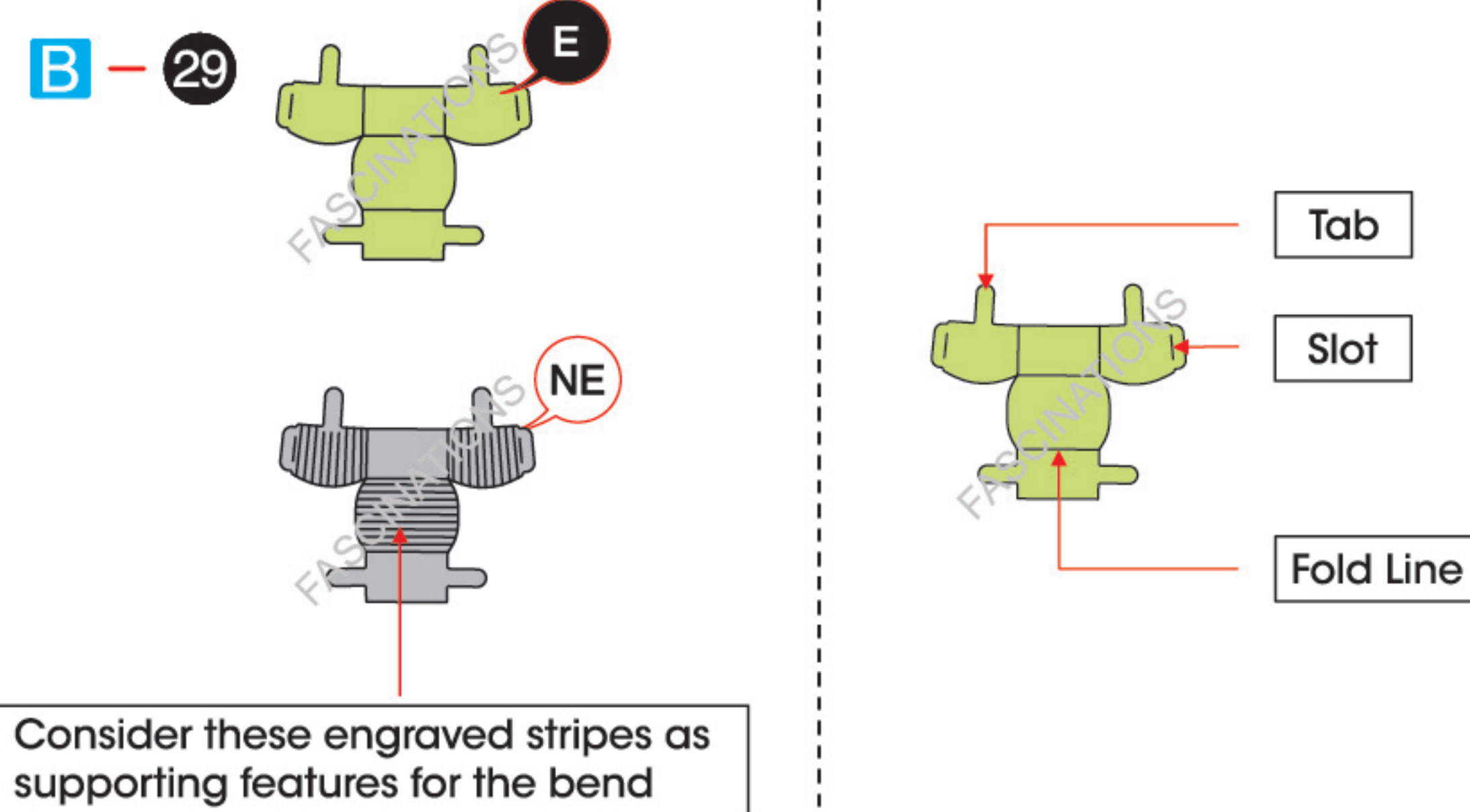

Consider these engraved stripes as supporting features for the bend

Legends:

- E** Engraved/ Color side
- NE** Non - engraved/ Silver side
- Attention point
- Insert tab and bend 90 degrees
- Insert tab and twist 90 degrees

Assembly tip:

If needed, slightly twist tabs to hold parts together then untwist and bend them down for a nice finish.

- Yellow areas should be curled
- Red areas should be folded

Recommended tools:

- Wire cutters: helpful for taking parts from the metal sheets.



- Tweezers or needle nose pliers: helpful for folding parts, bending and twisting tabs.

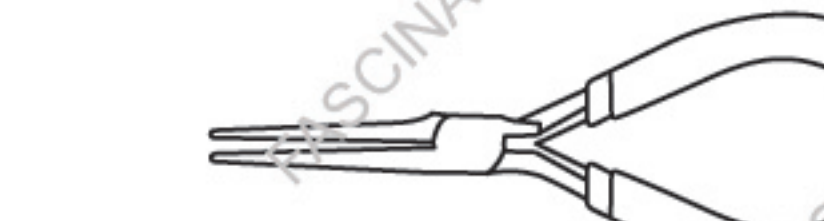

METAL SHEETS

Parts with same color are duplicates

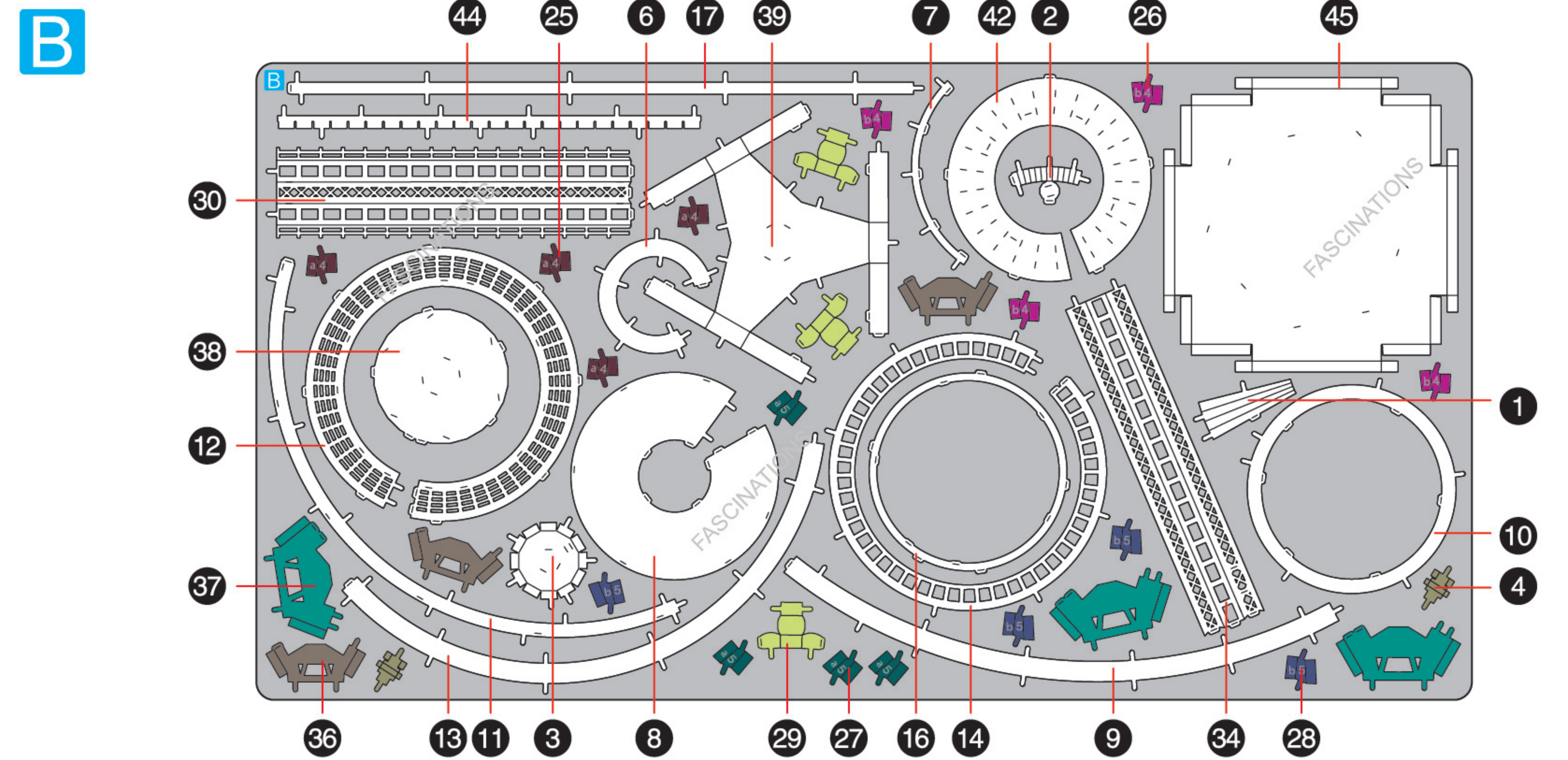
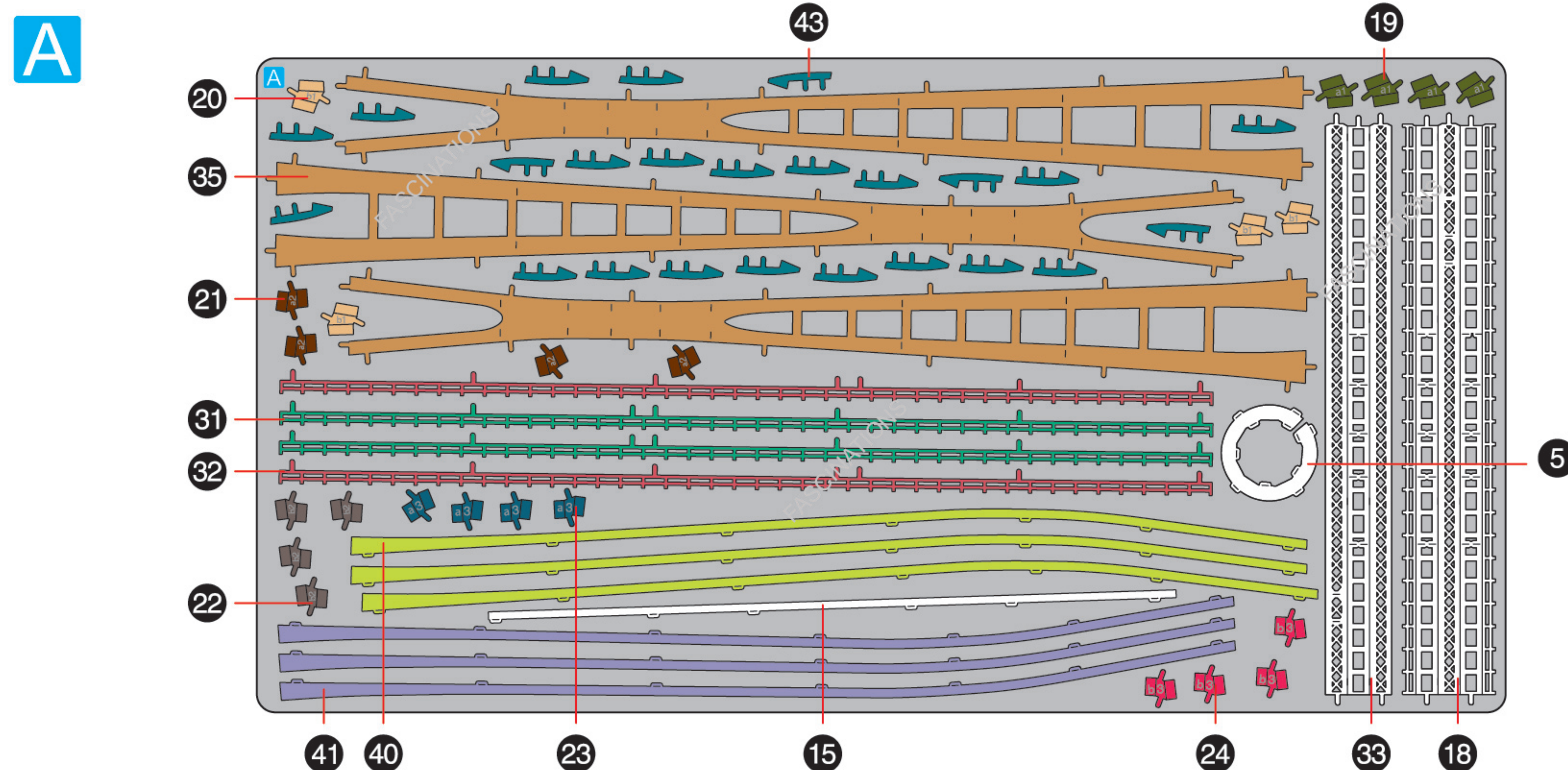

ASSEMBLY STEPS

Step 1

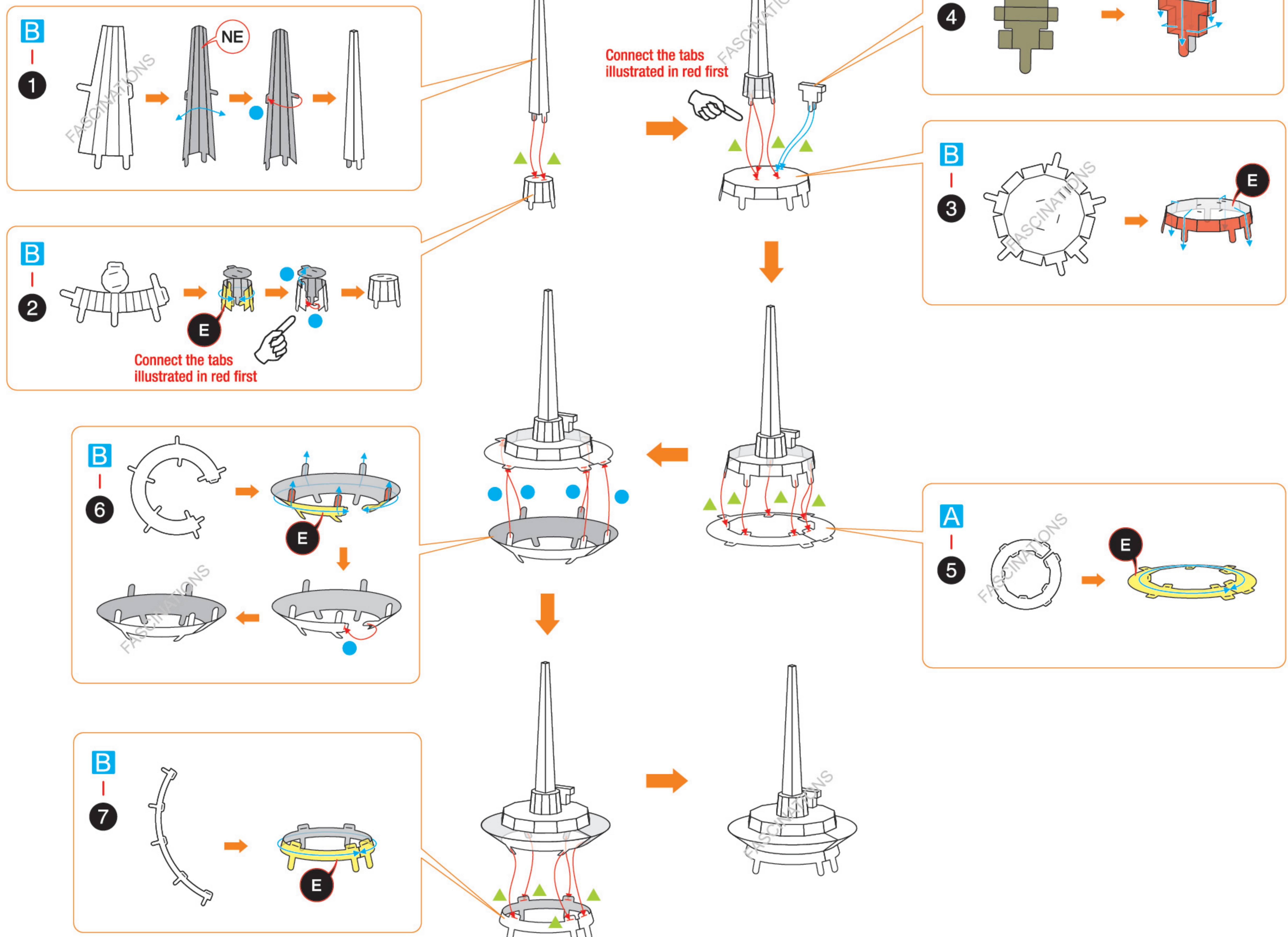

In order to avoid possible injury from sharp edges, please carefully discard the metal sheets after parts have been removed.

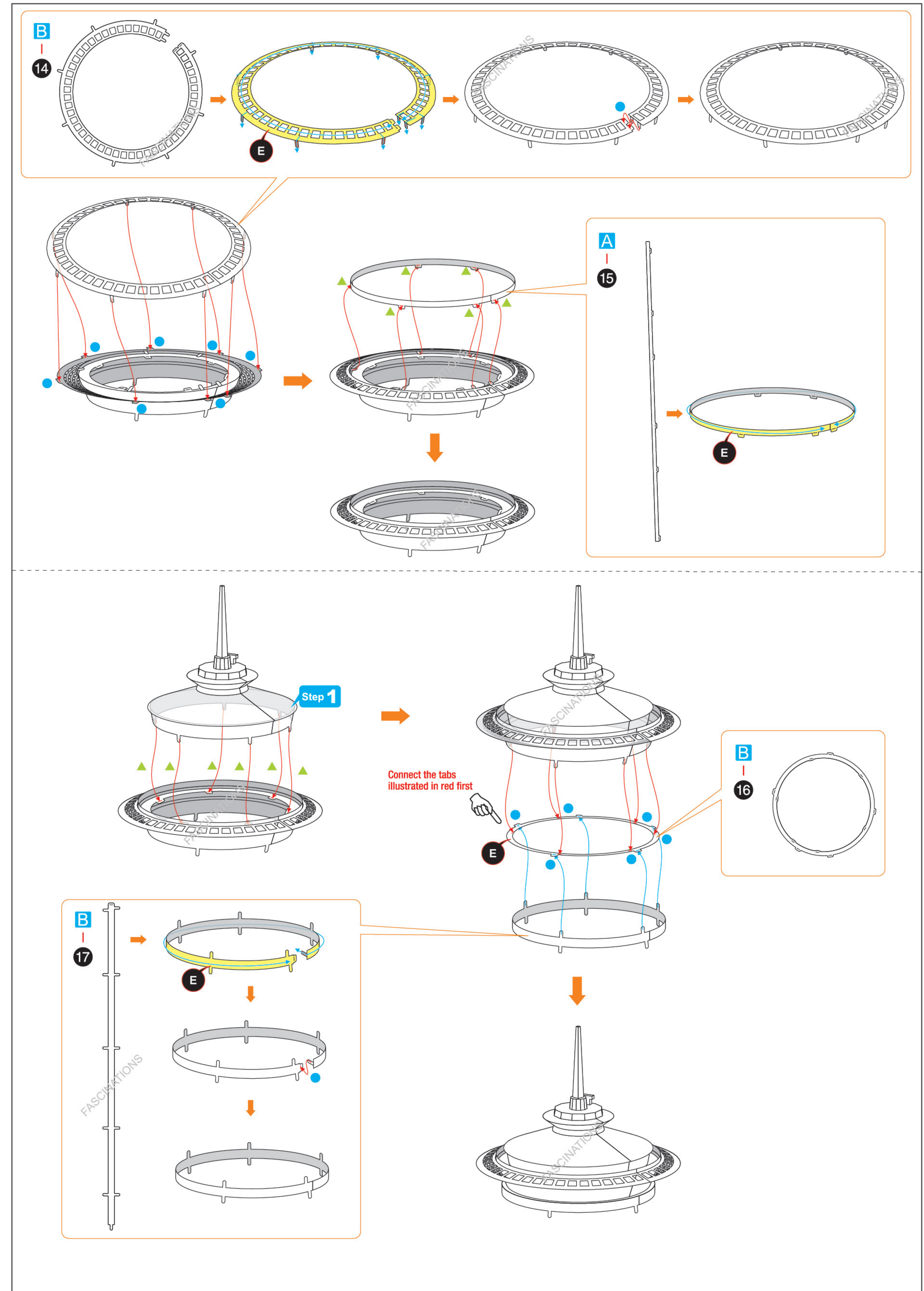
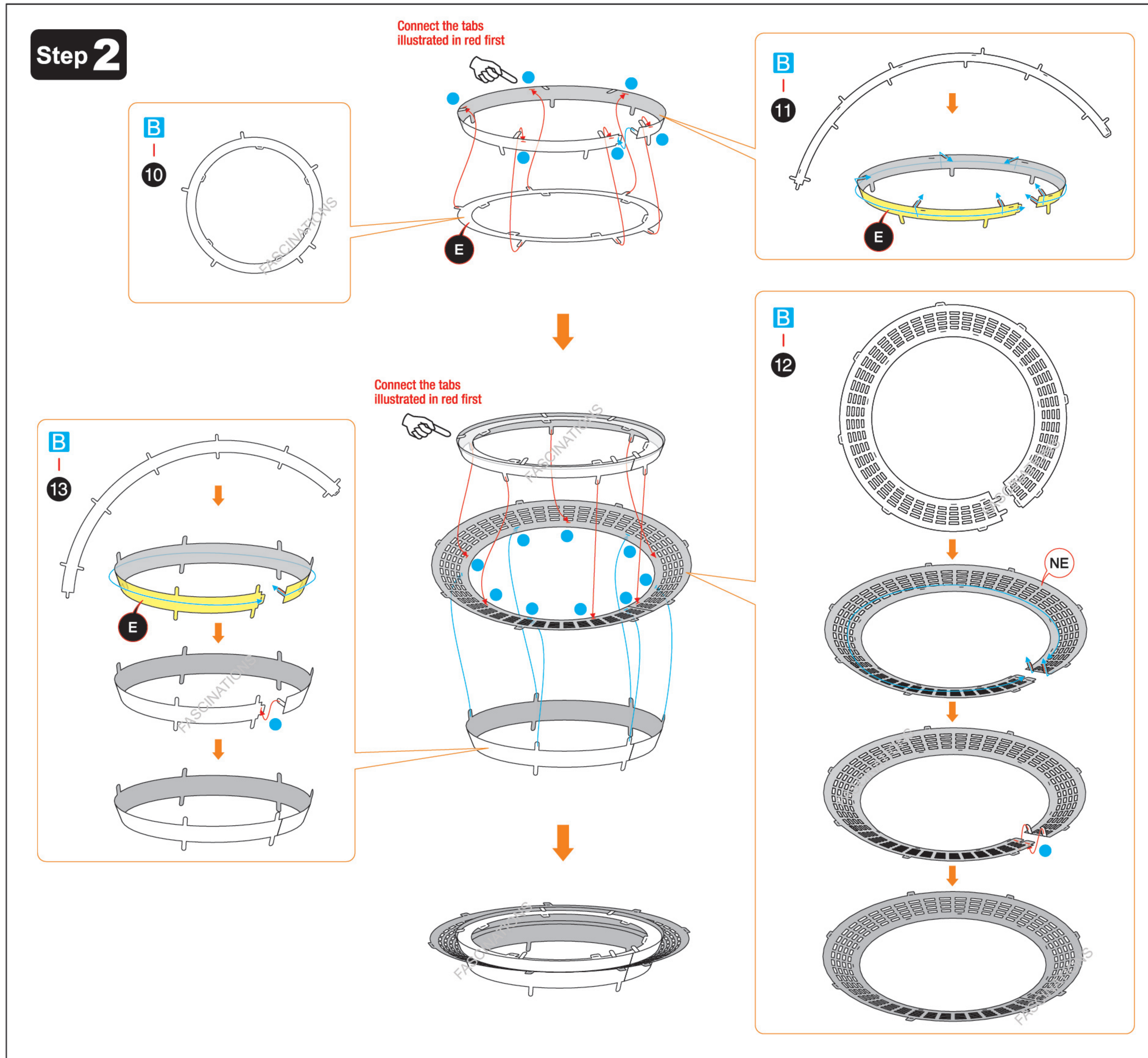
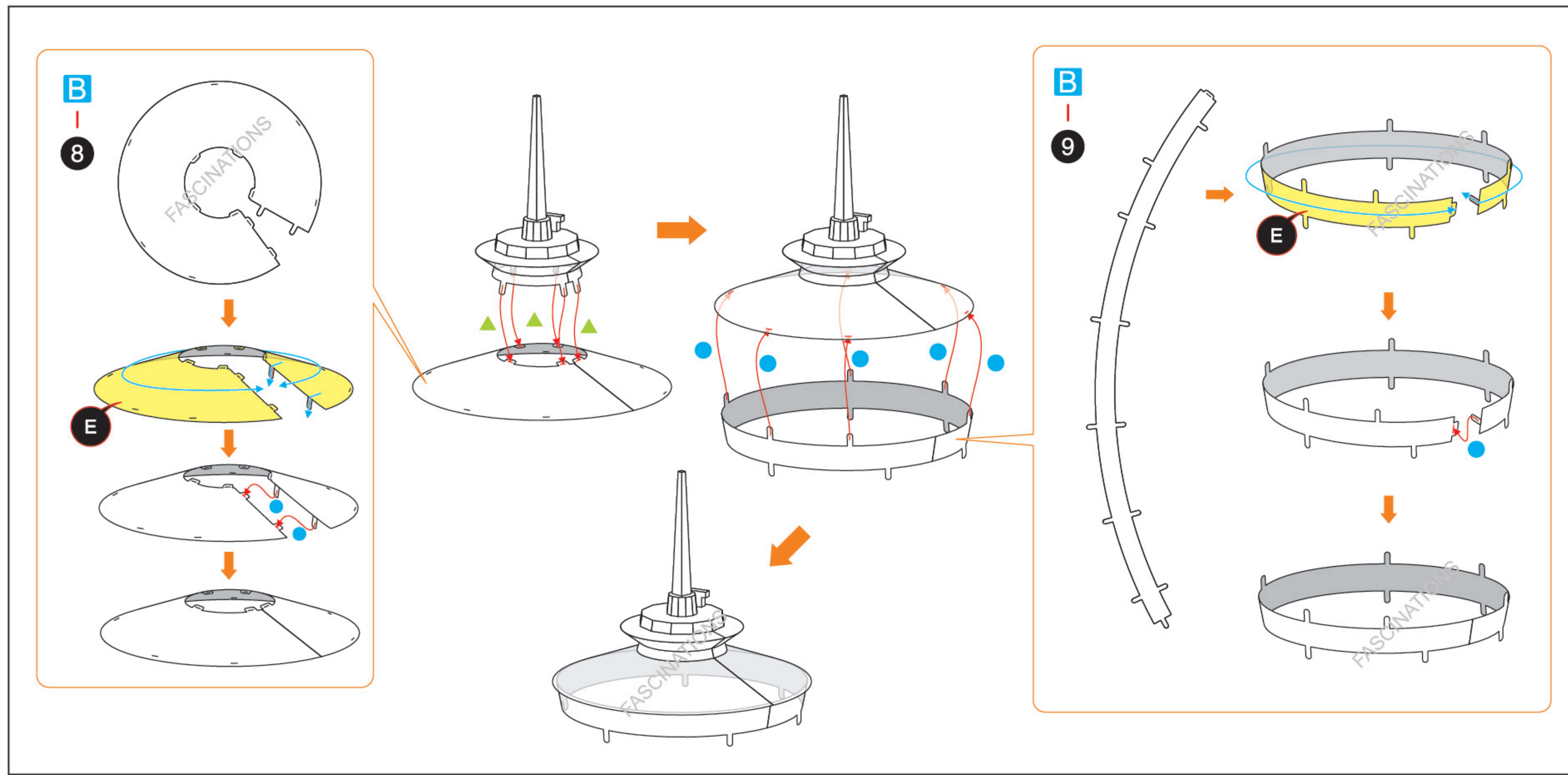

Step 3

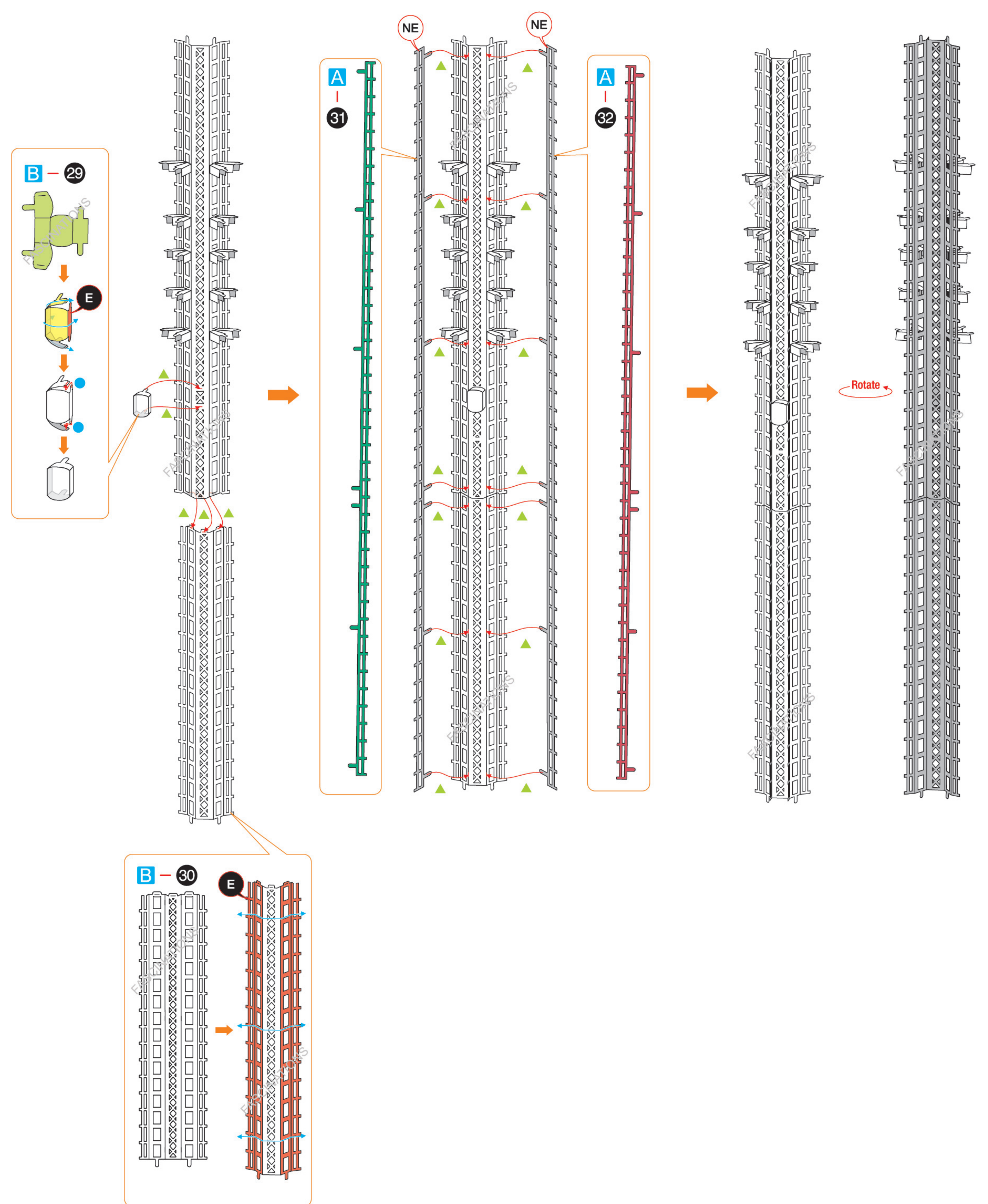
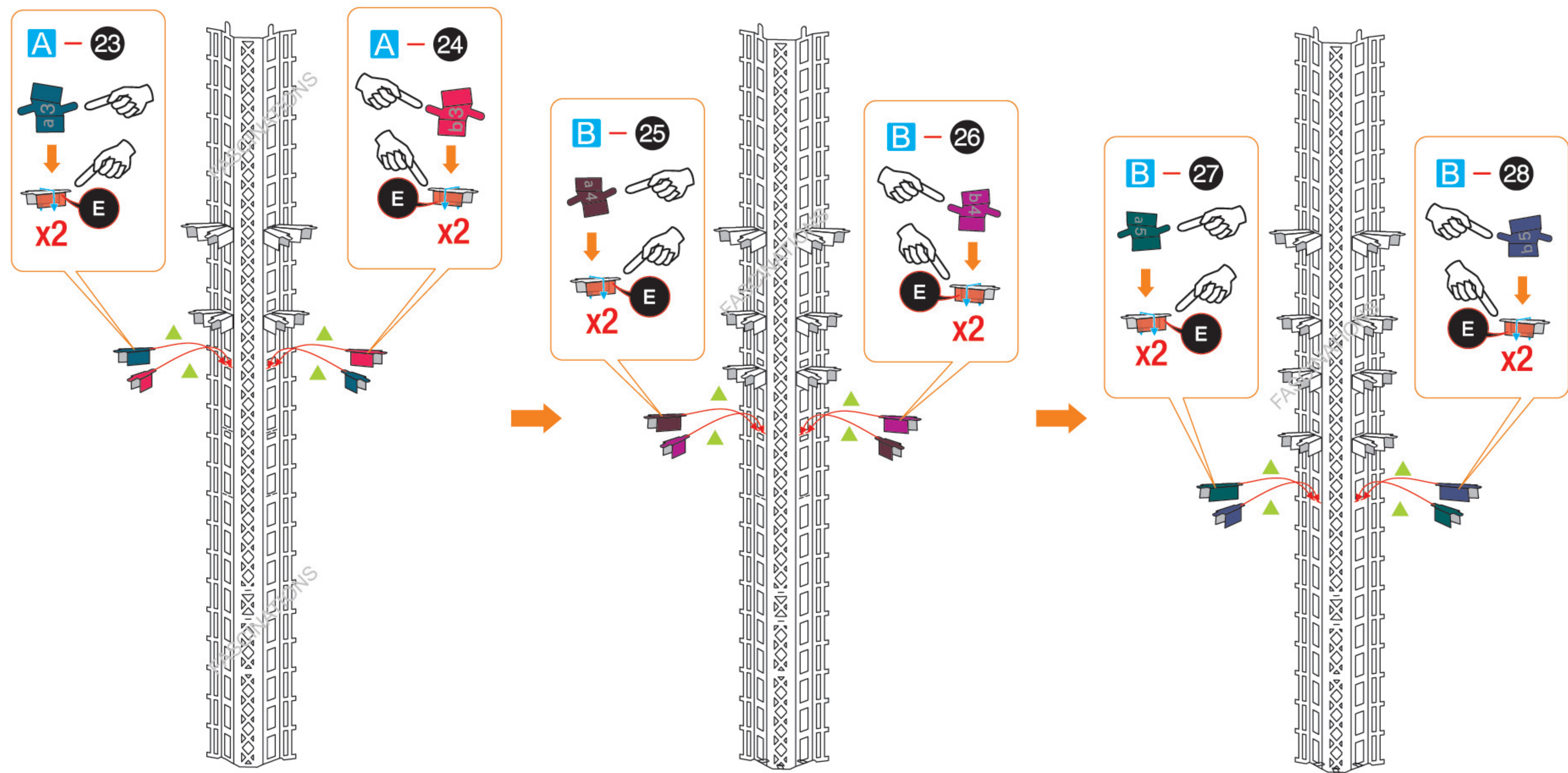
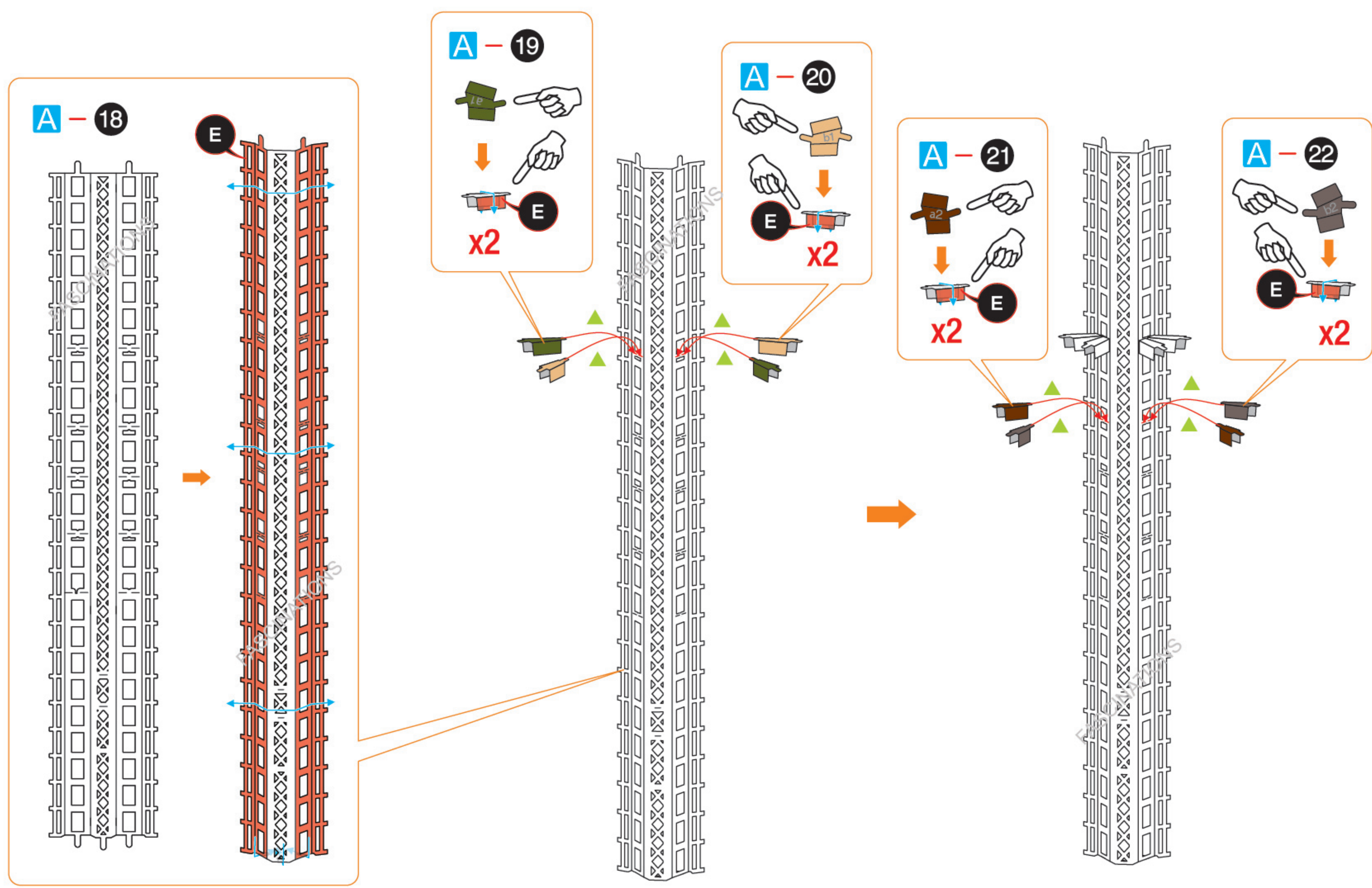

Step 4

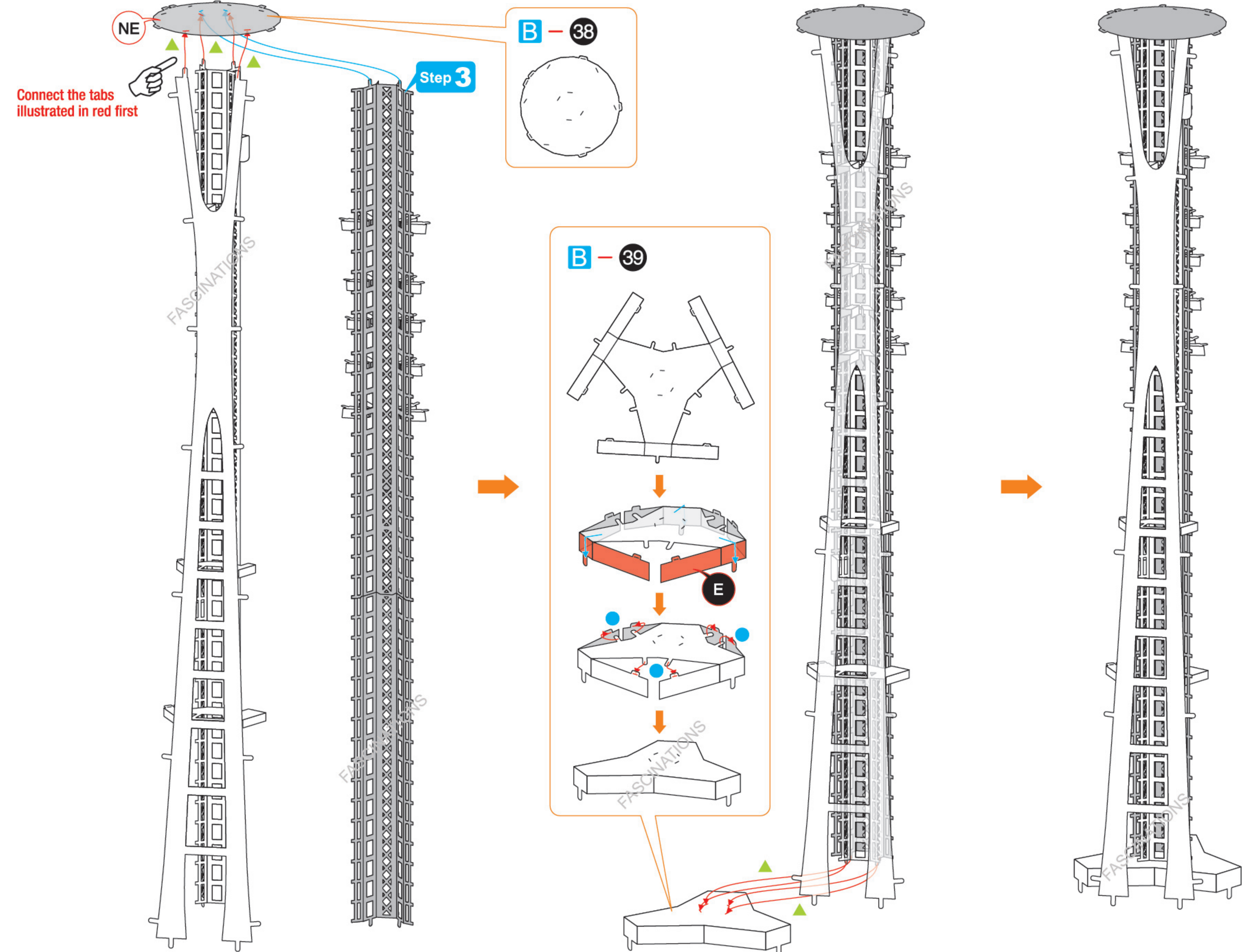
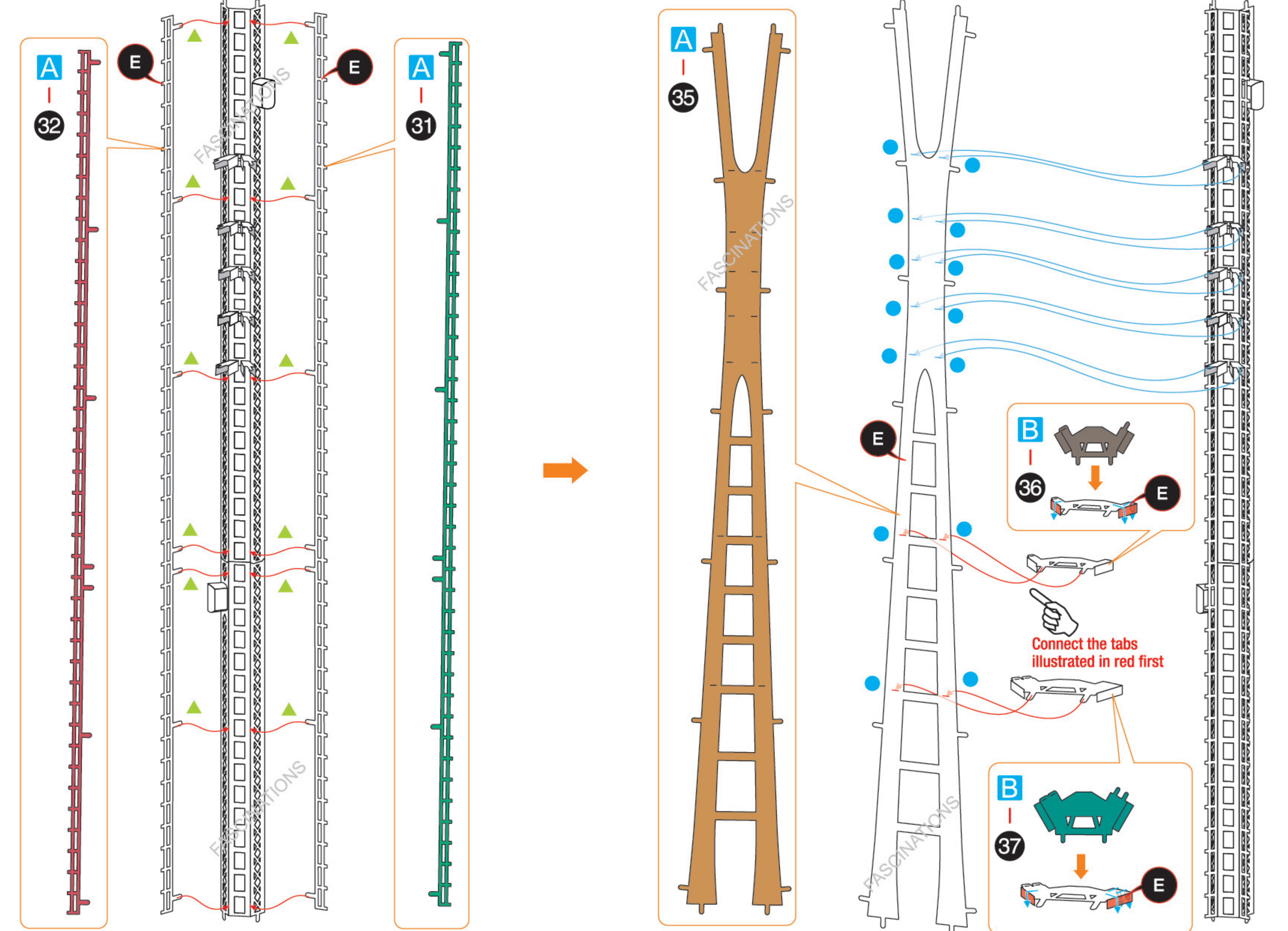
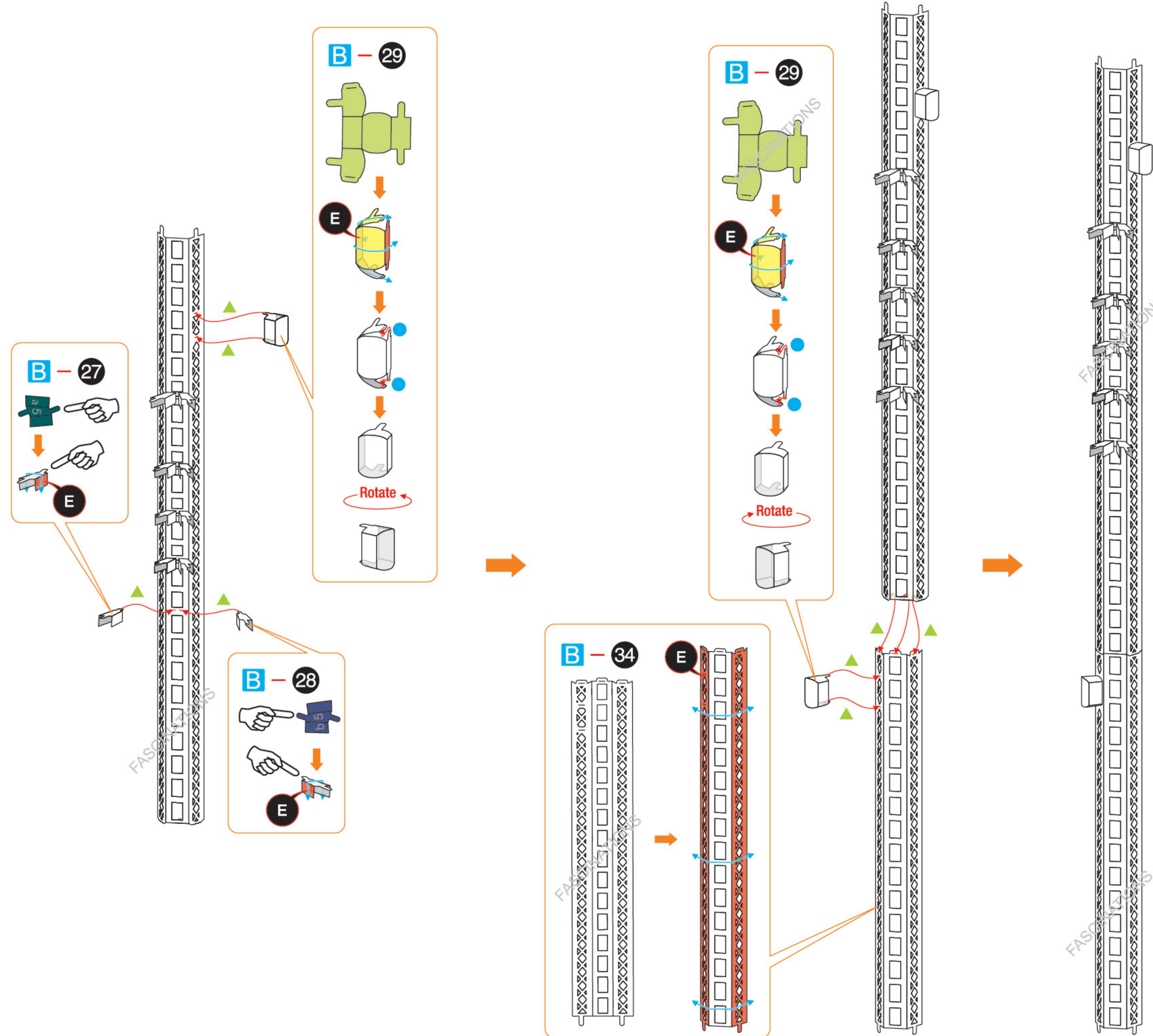
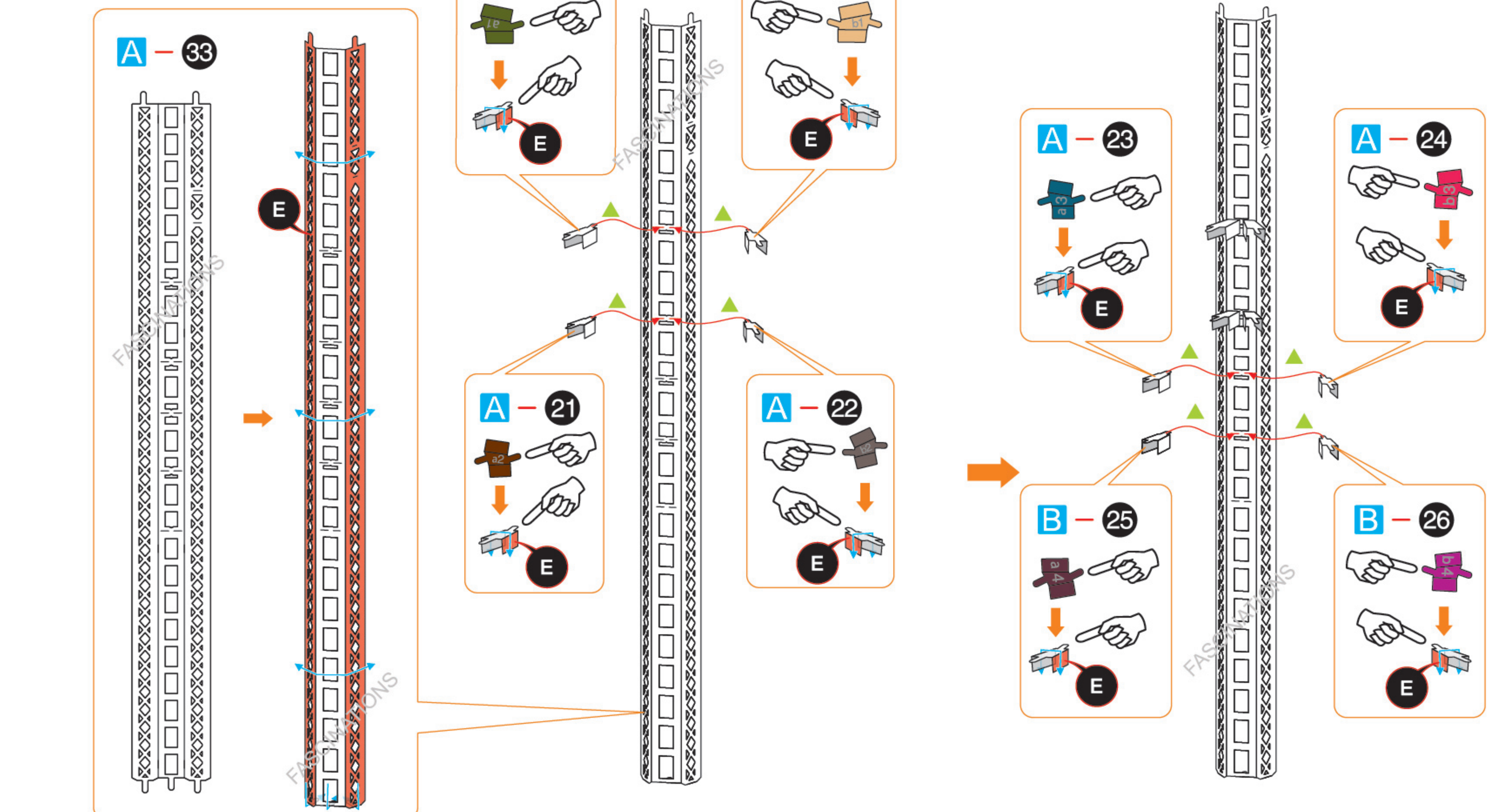

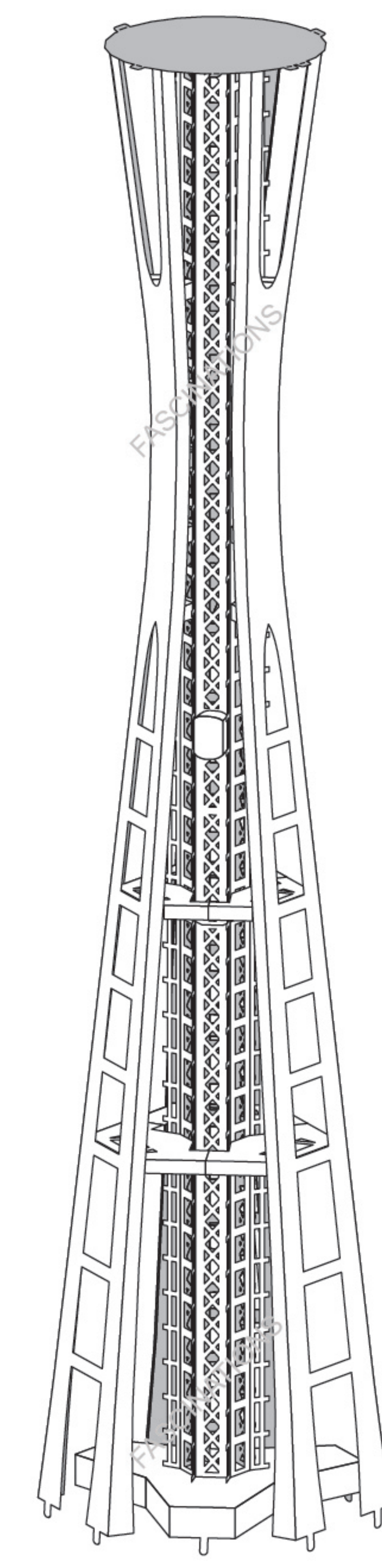
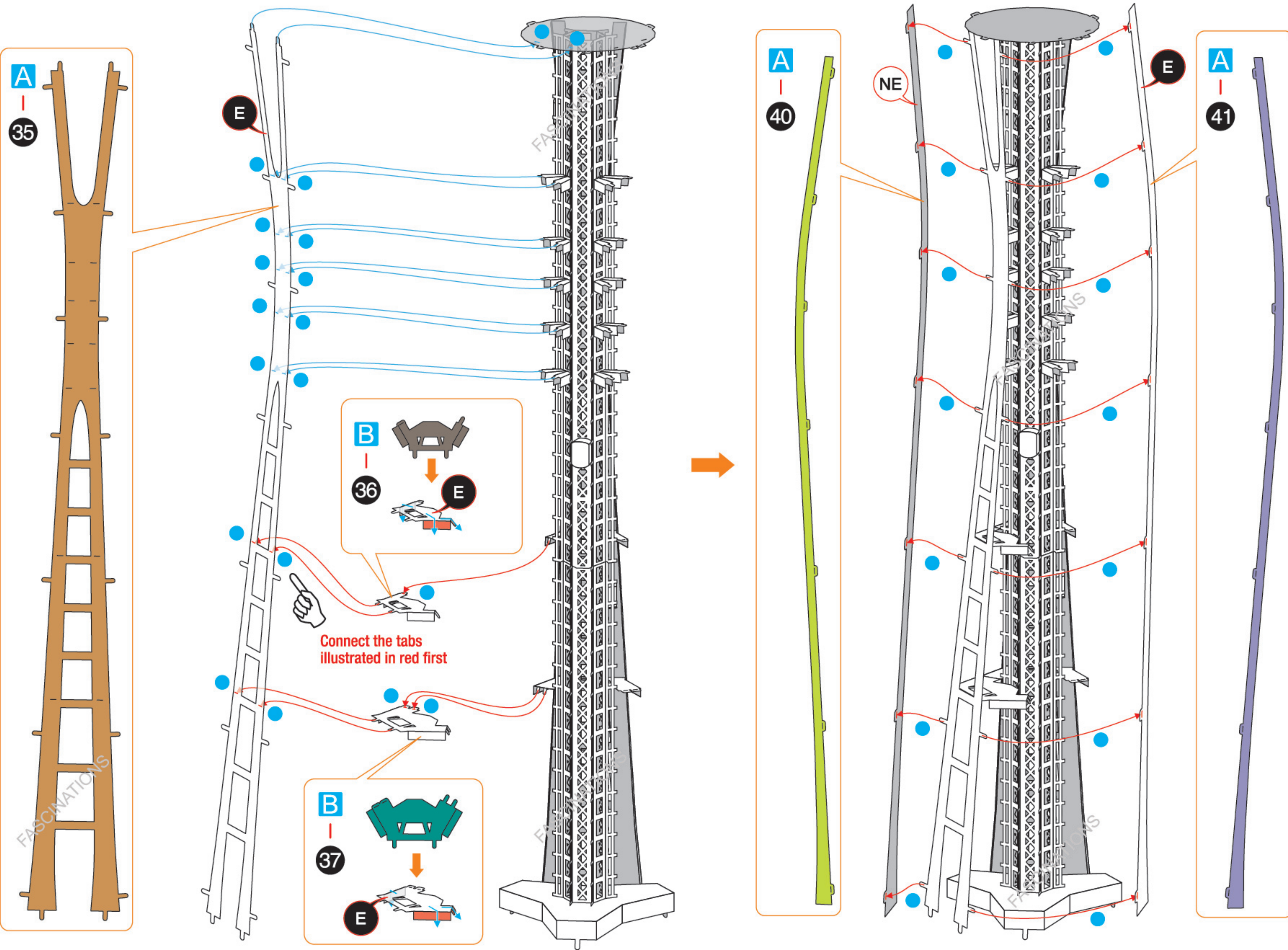
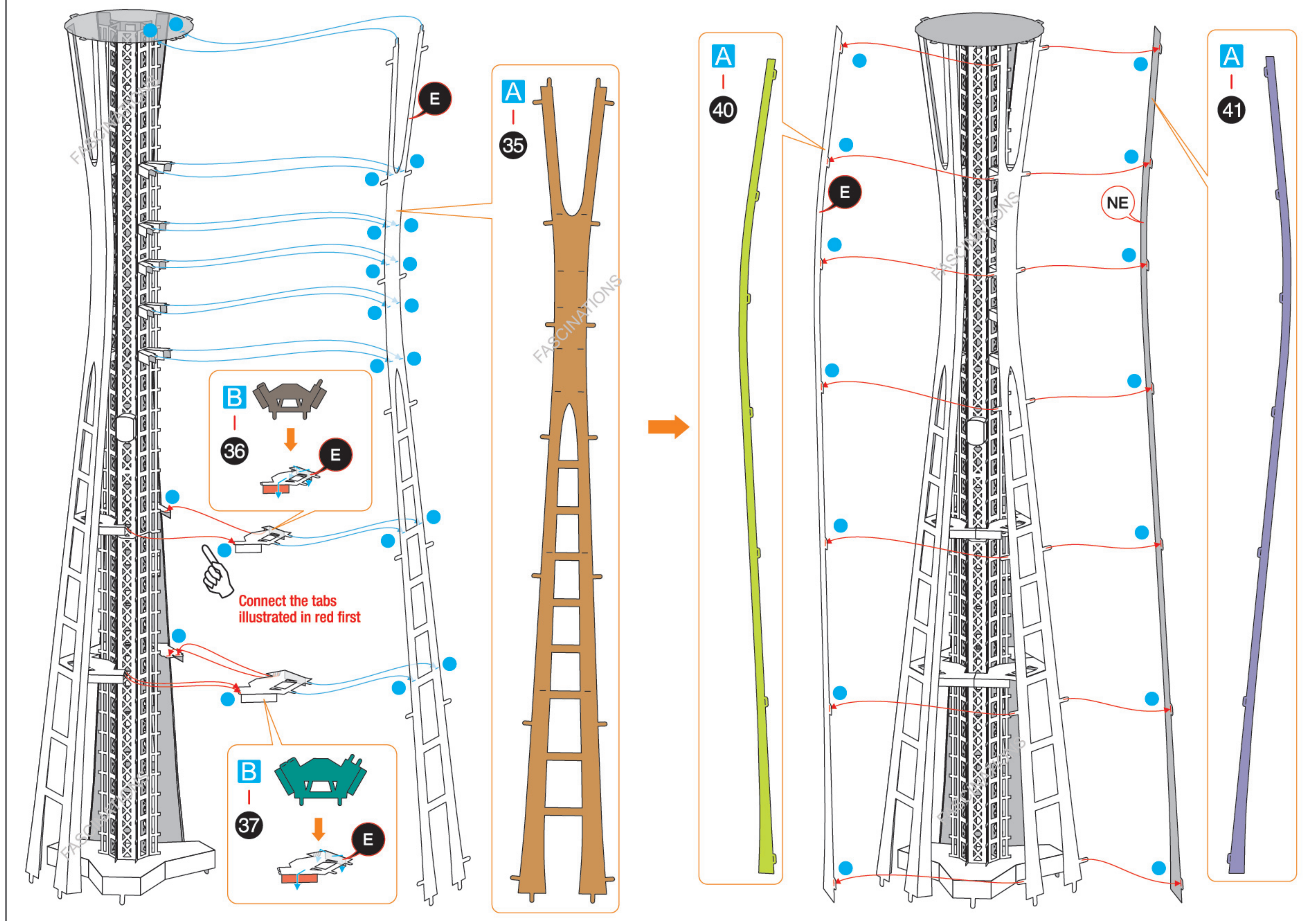
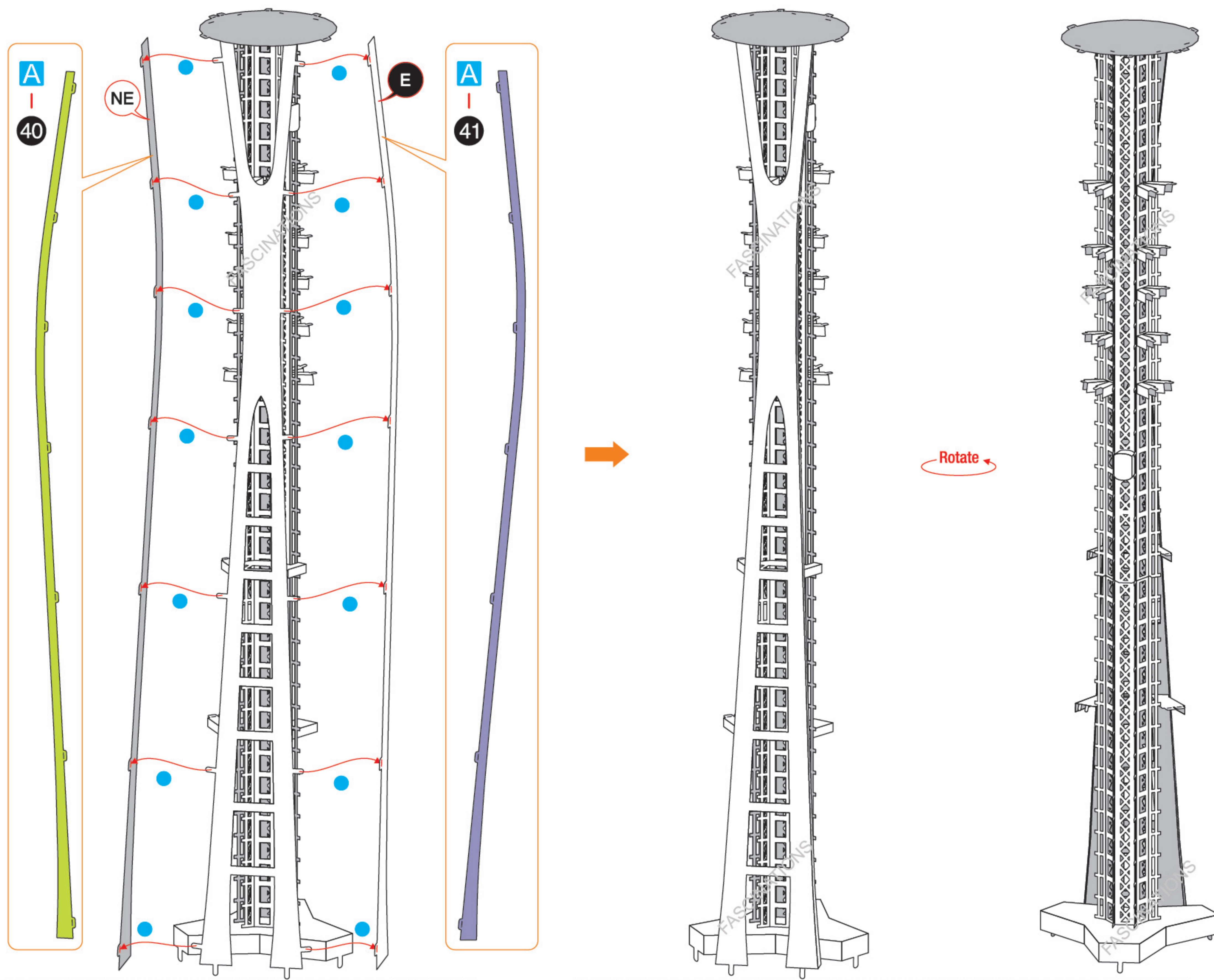

Step 5

