

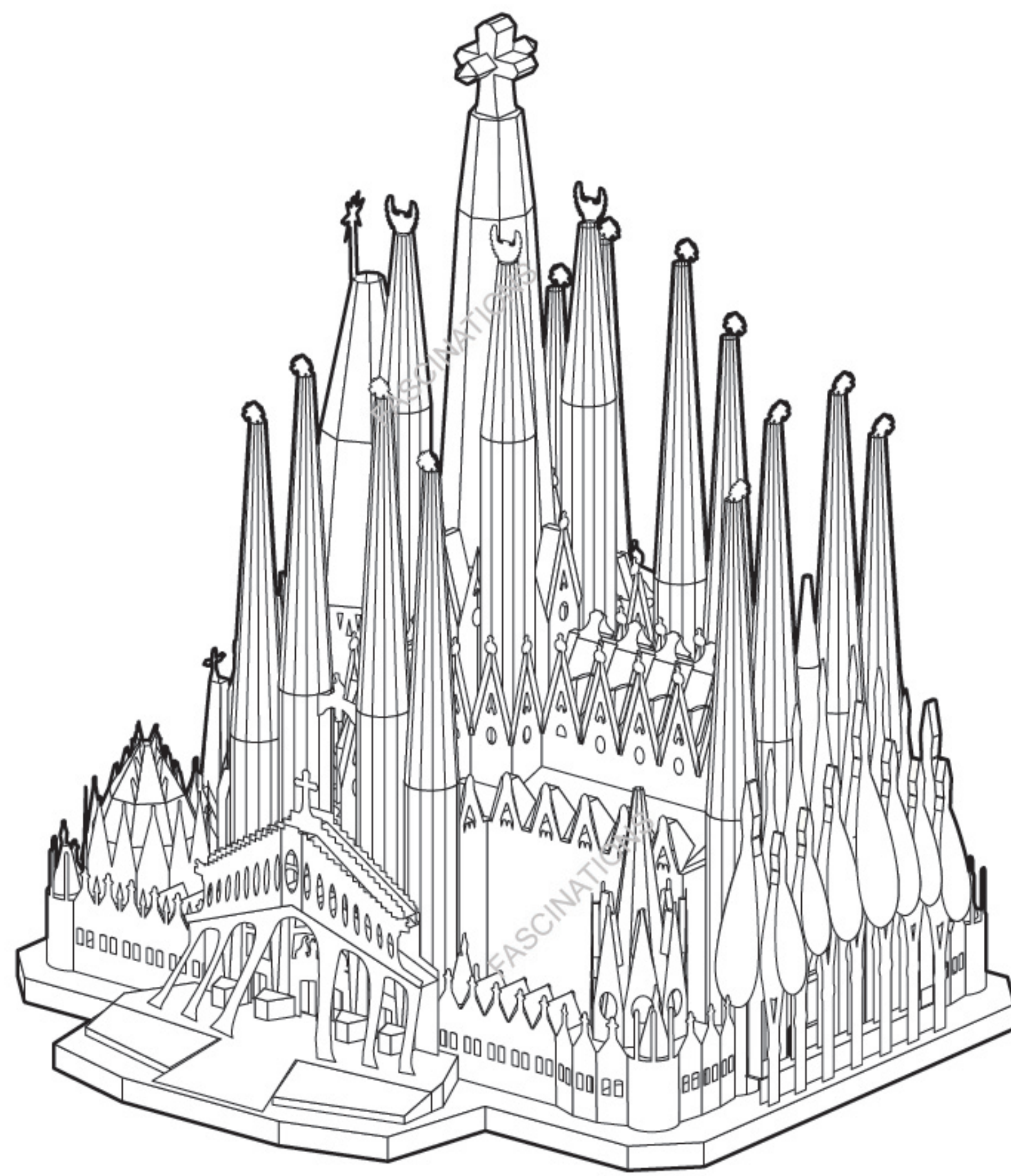

It is highly recommended that you visit [www.metalearth.com/360/ICX258](http://www.metalearth.com/360/ICX258) to see the completed model before assembling your own

## ICX258 SAGRADA FAMILIA



### TO CREATE THE BEST CONNECTIONS

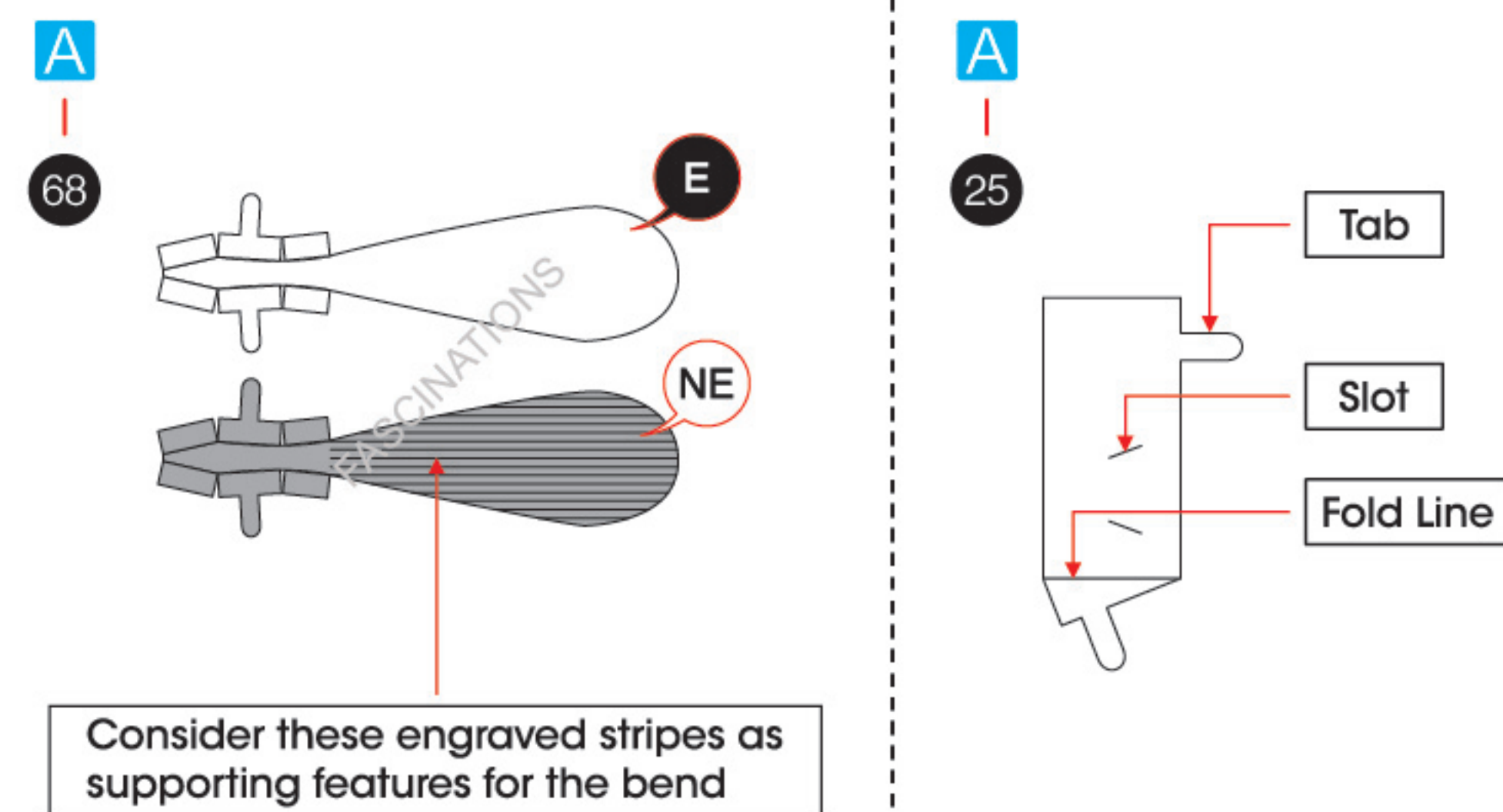

Consider these engraved stripes as supporting features for the bend

**Legends:**

- E Engraved/ Color side
- NE Non - engraved/ Silver side
- Attention point
- Insert tab and bend 90 degrees
- ▲ Insert tab and twist 90 degrees

**Assembly tip:**

If needed, slightly twist tabs to hold parts together then untwist and bend them down for a nice finish.

- Yellow areas should be curled
- Red areas should be folded

**Recommended tools:**

- Wire cutters: helpful for taking parts from the metal sheets.



- Tweezers or needle nose pliers: helpful for folding parts, bending and twisting tabs.

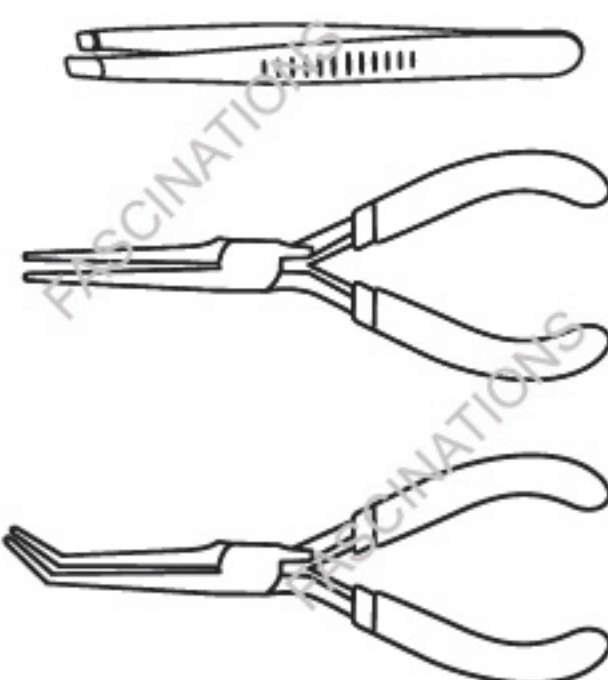

### METAL SHEETS

Parts with same color are duplicates

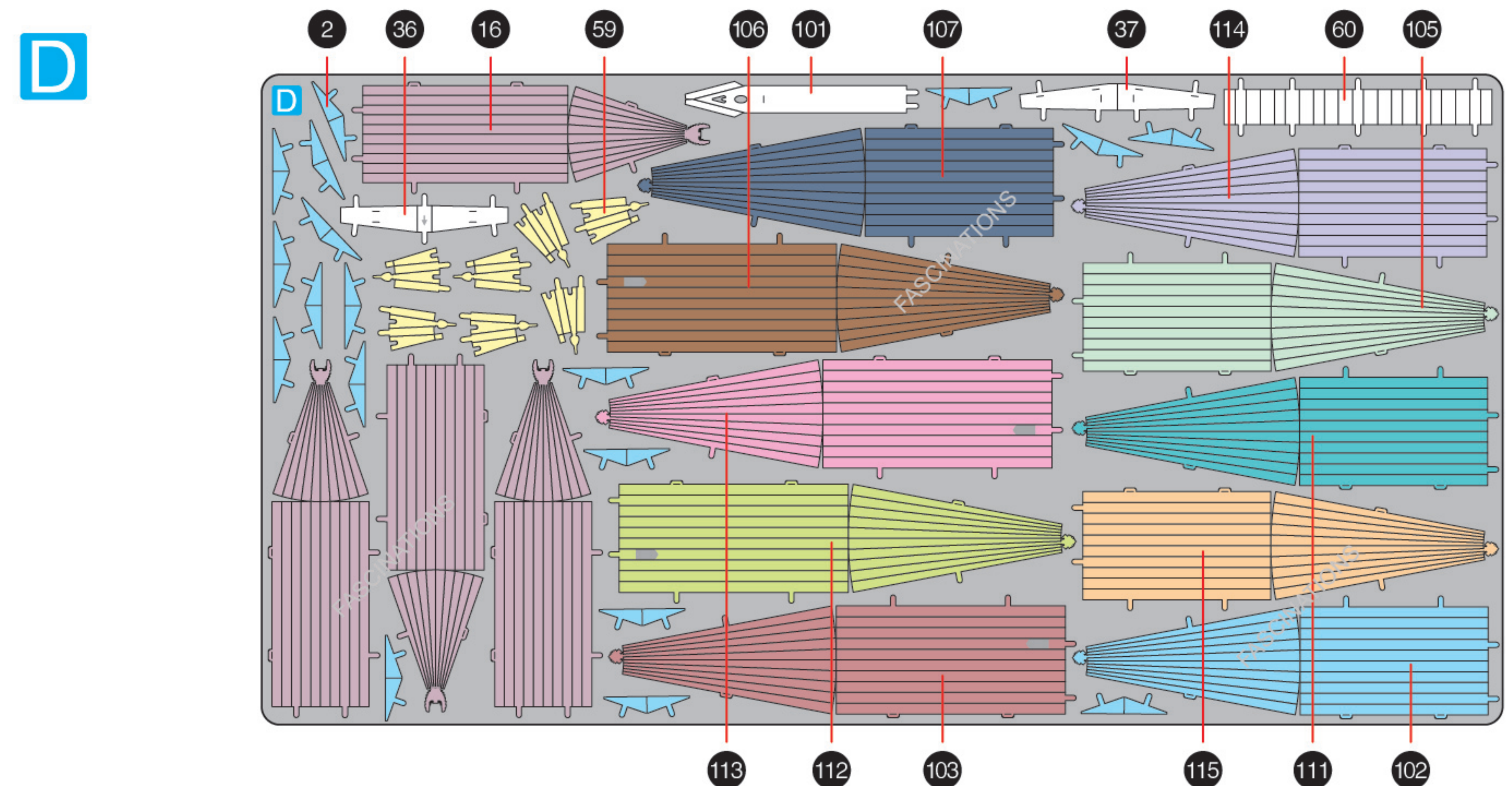
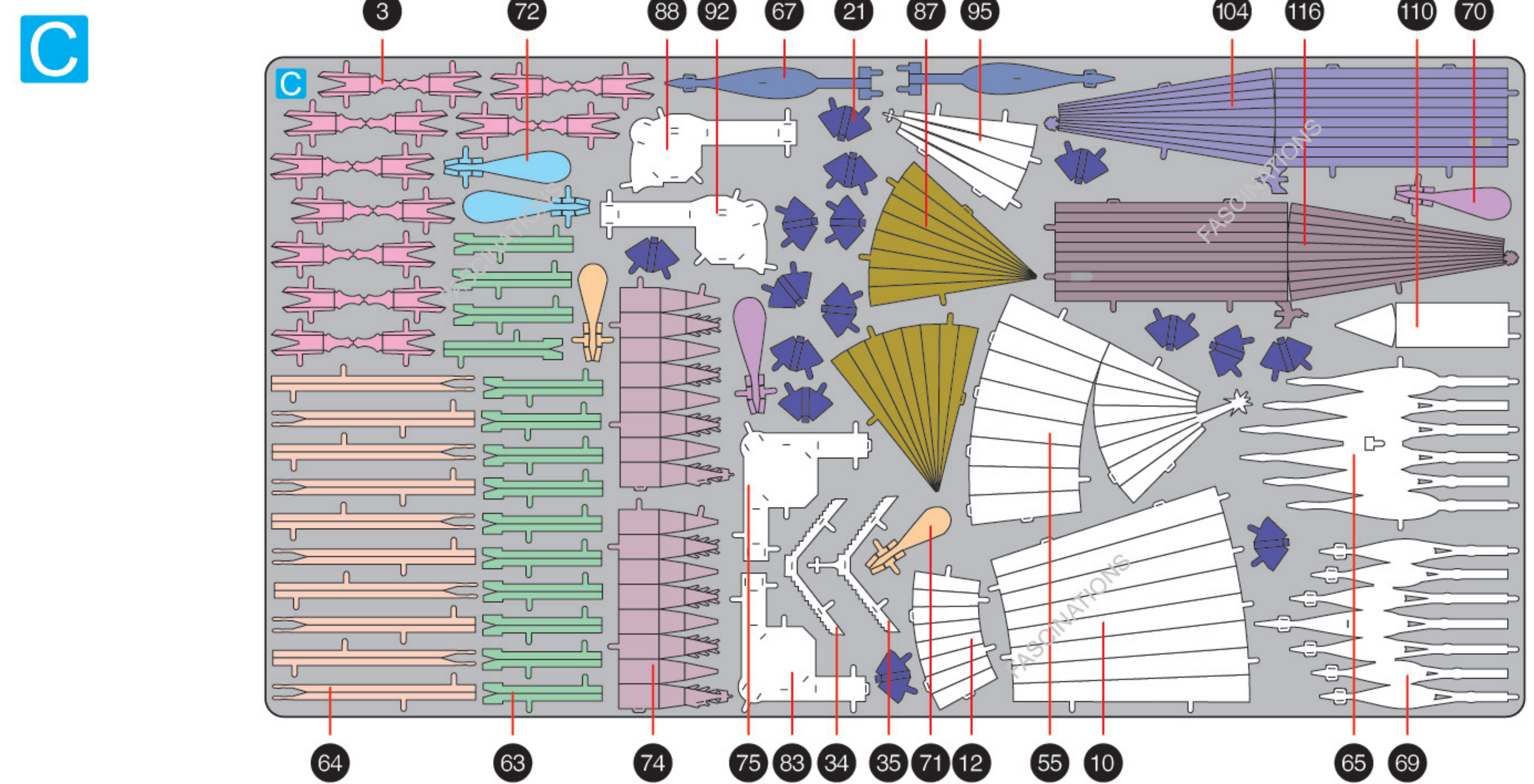
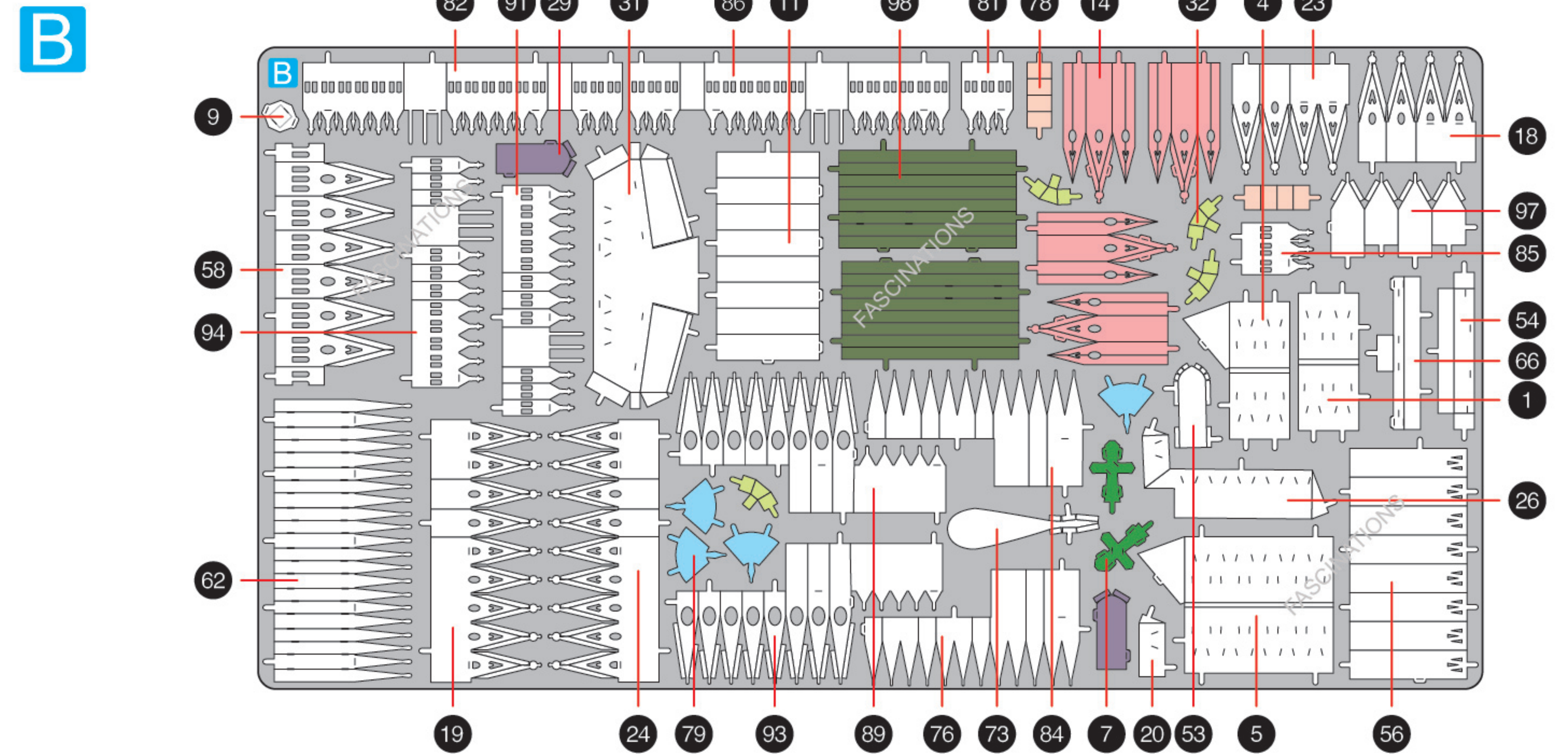
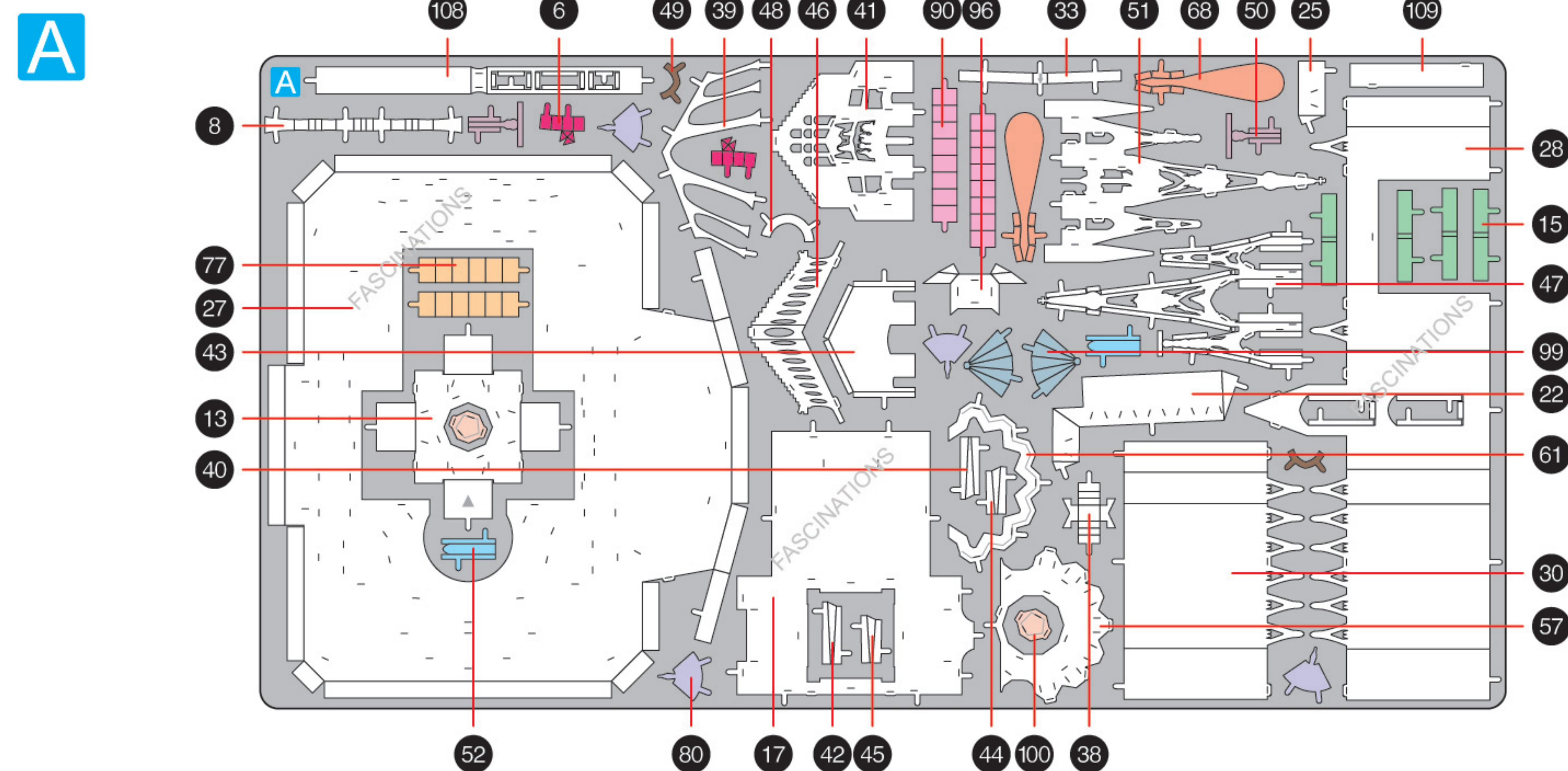

In order to avoid possible injury from sharp edges, please carefully discard the metal sheets after parts have been removed.

### ASSEMBLY STEPS

#### Step 1

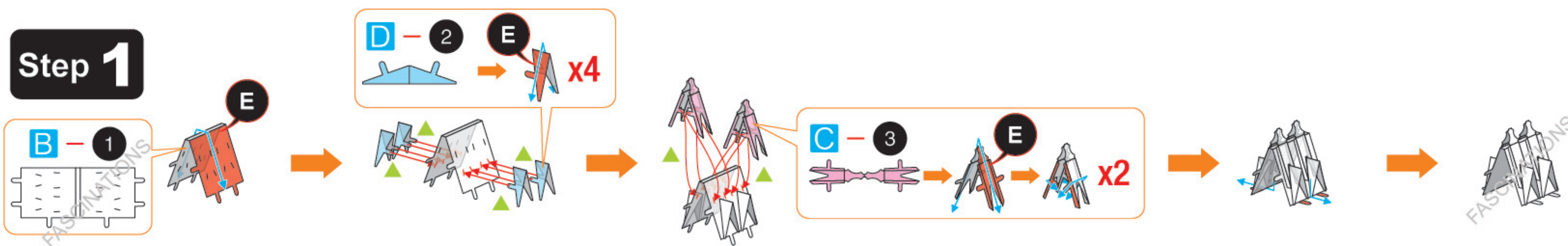

#### Step 2

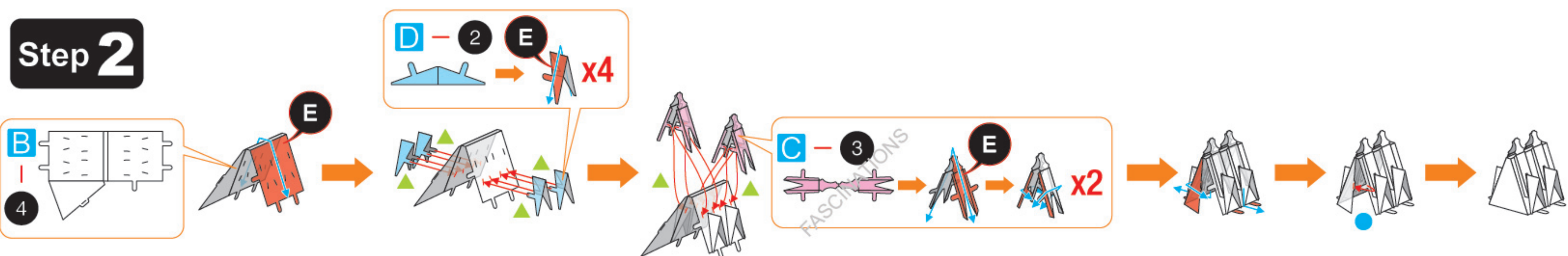

#### Step 3

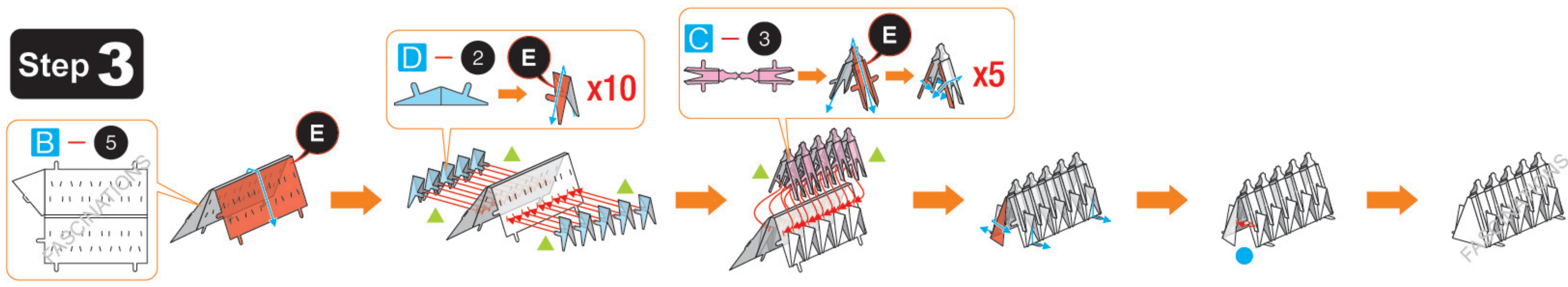

#### Step 4

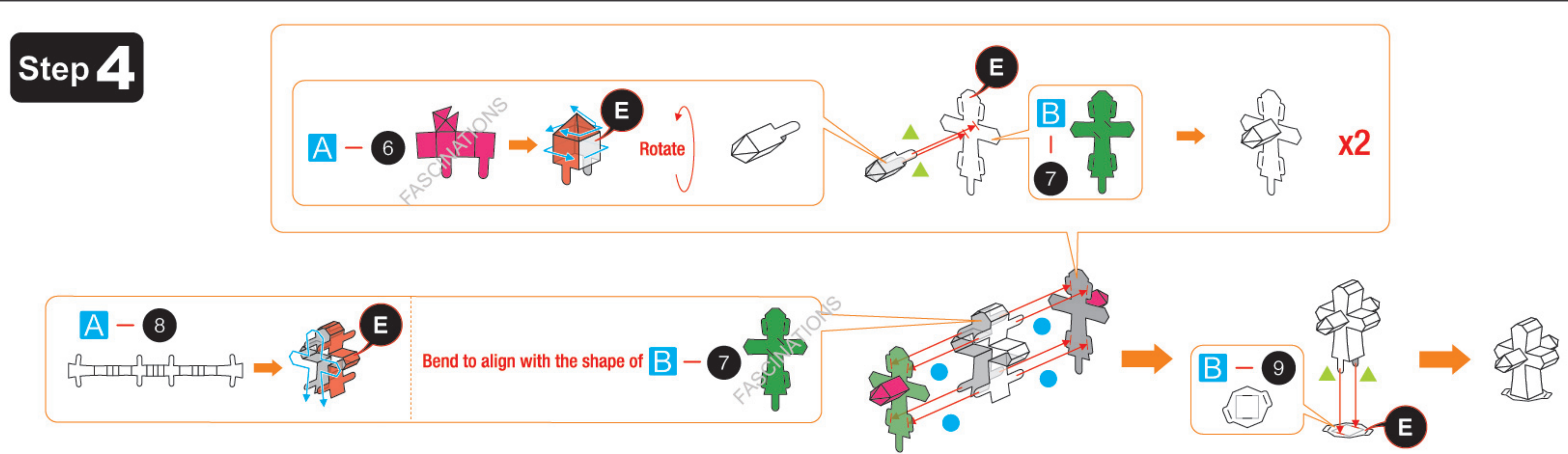

#### Step 5

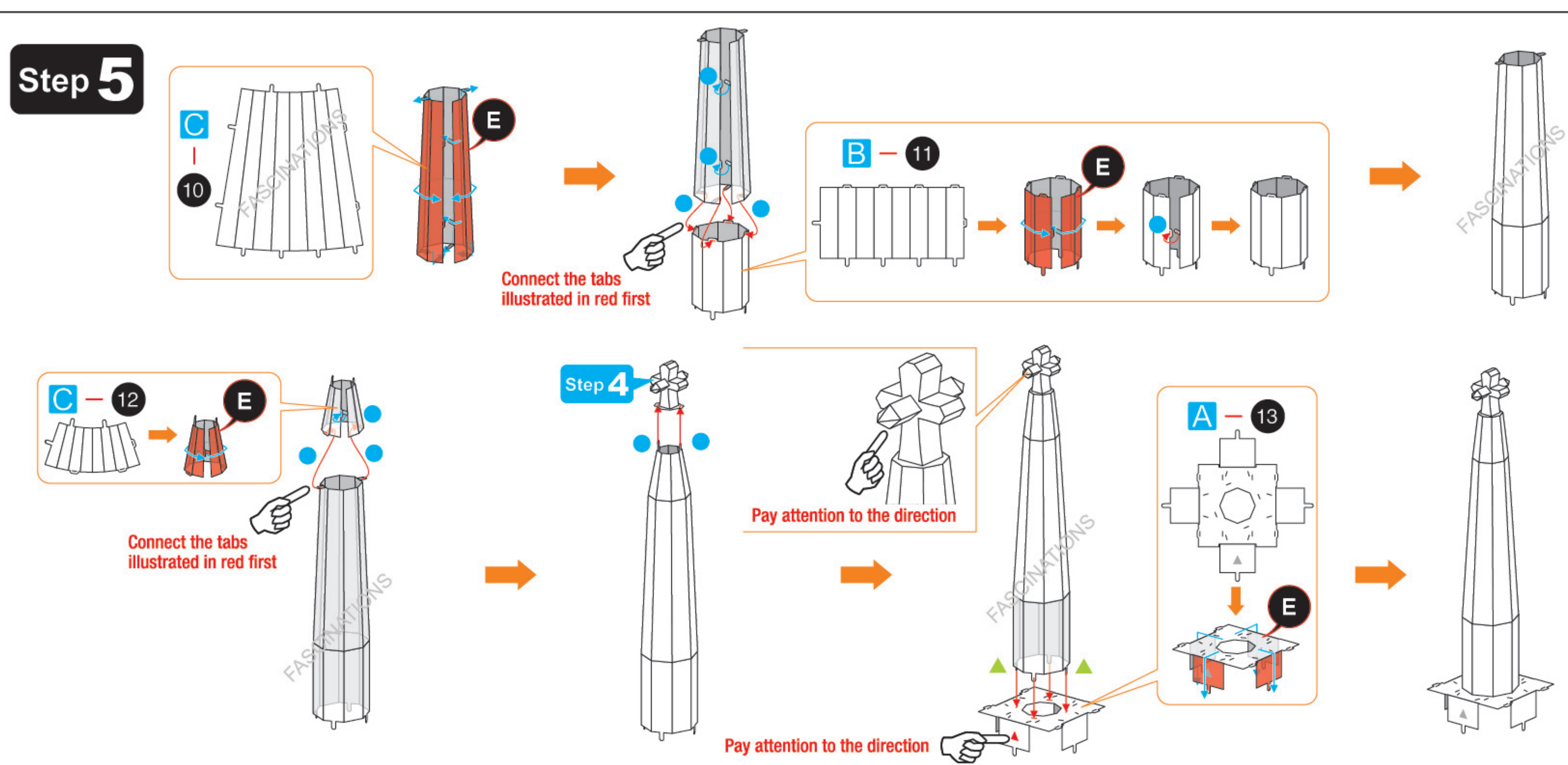

#### Step 6

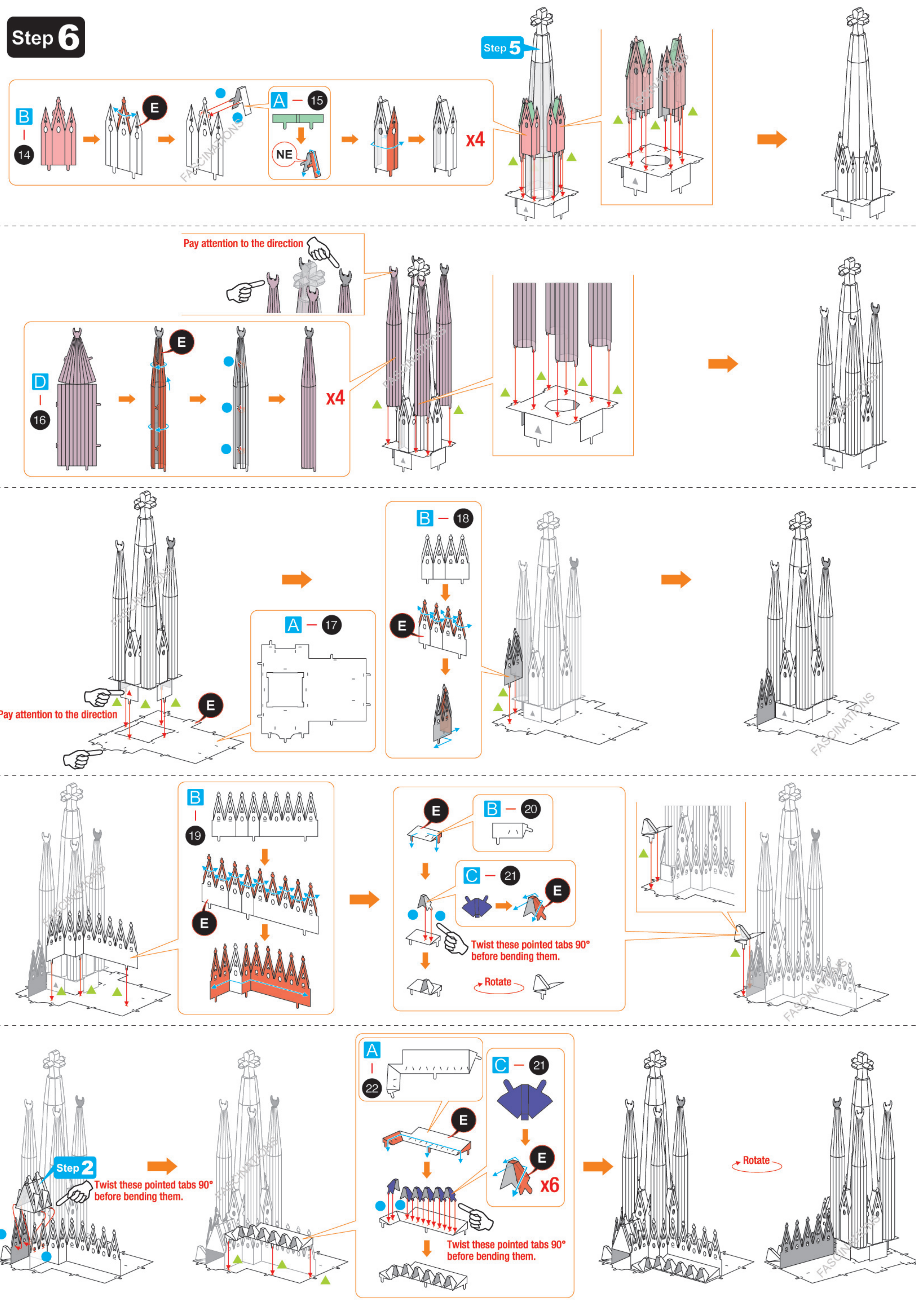

Step 7

Step 6

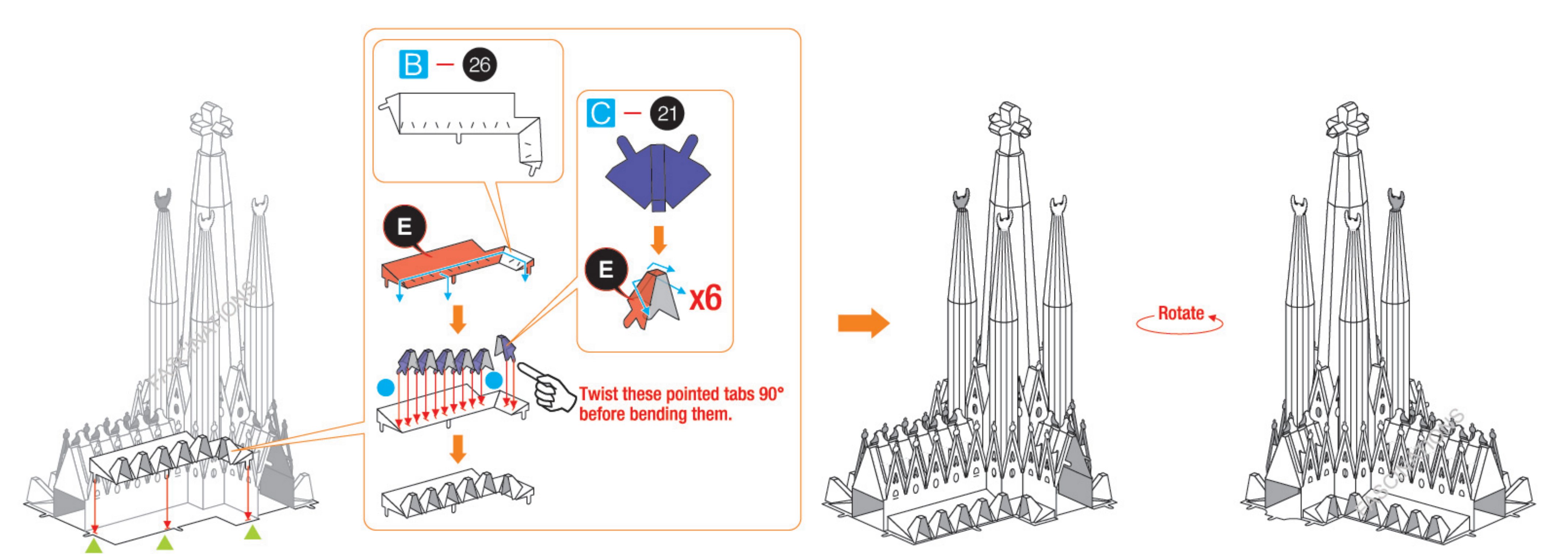
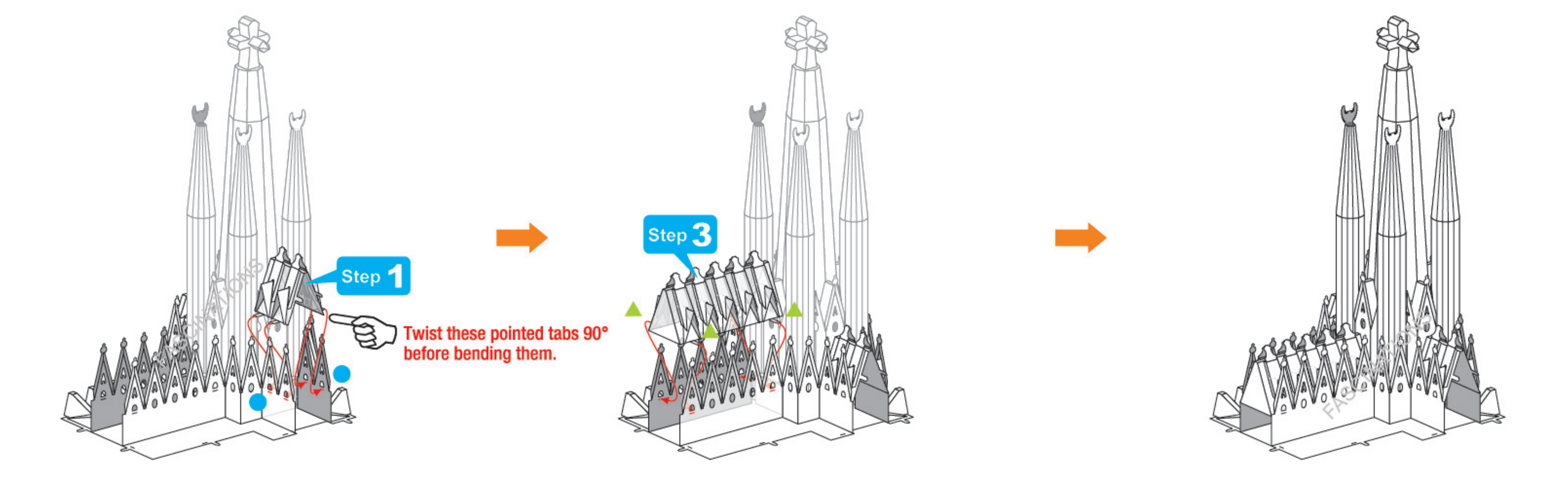
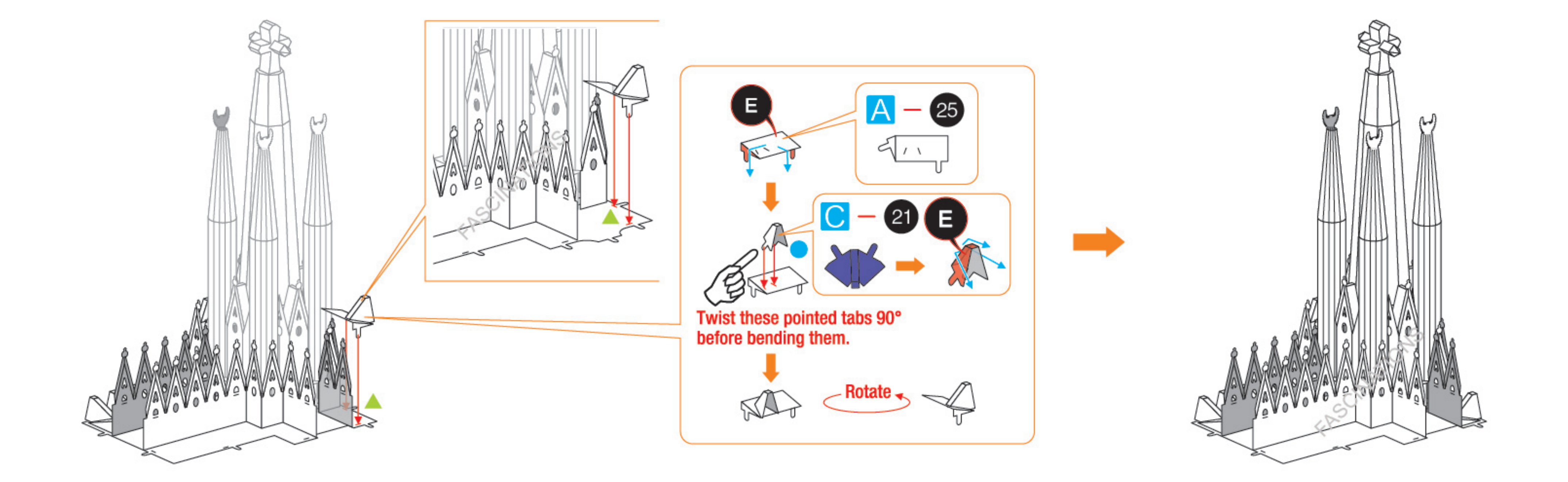
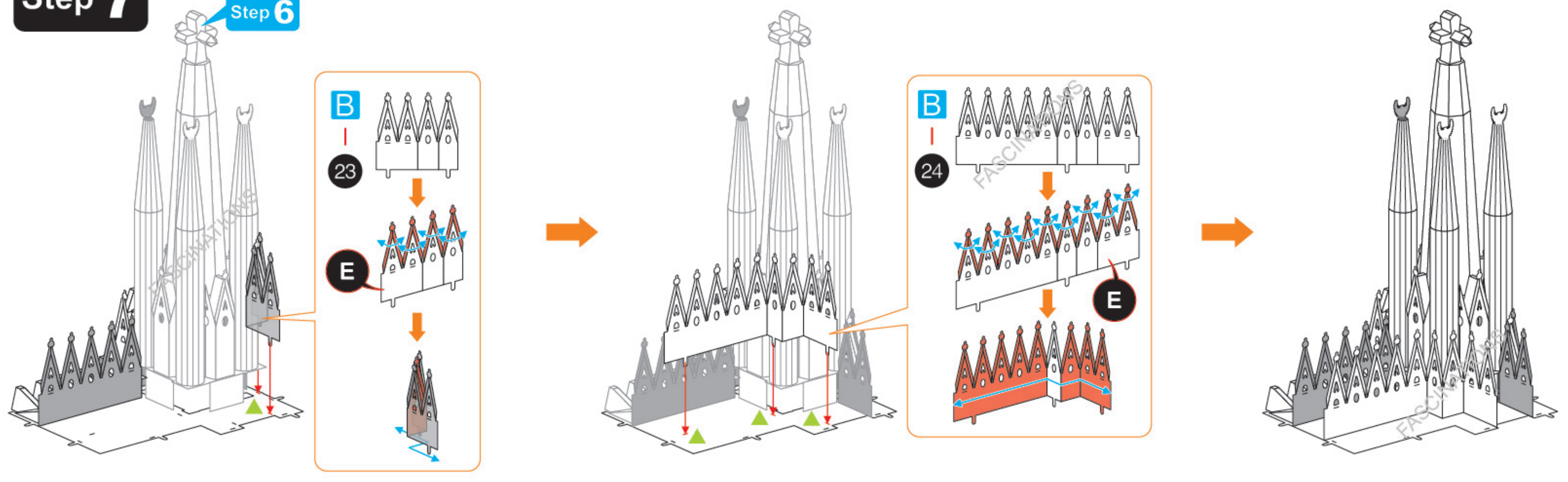

Step 8

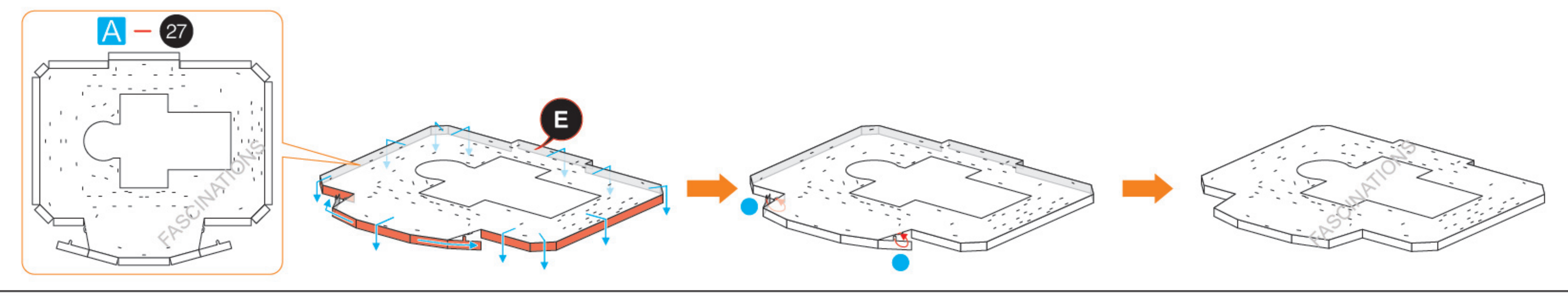

Step 9

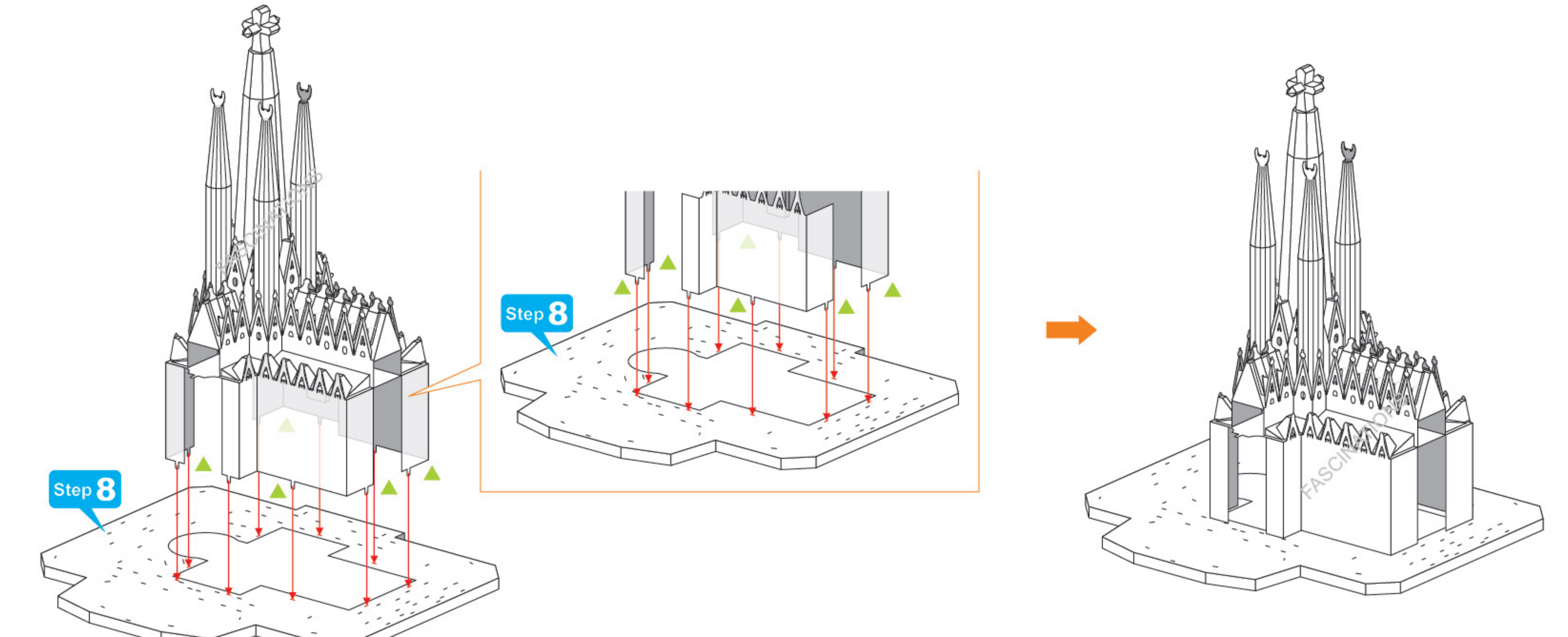
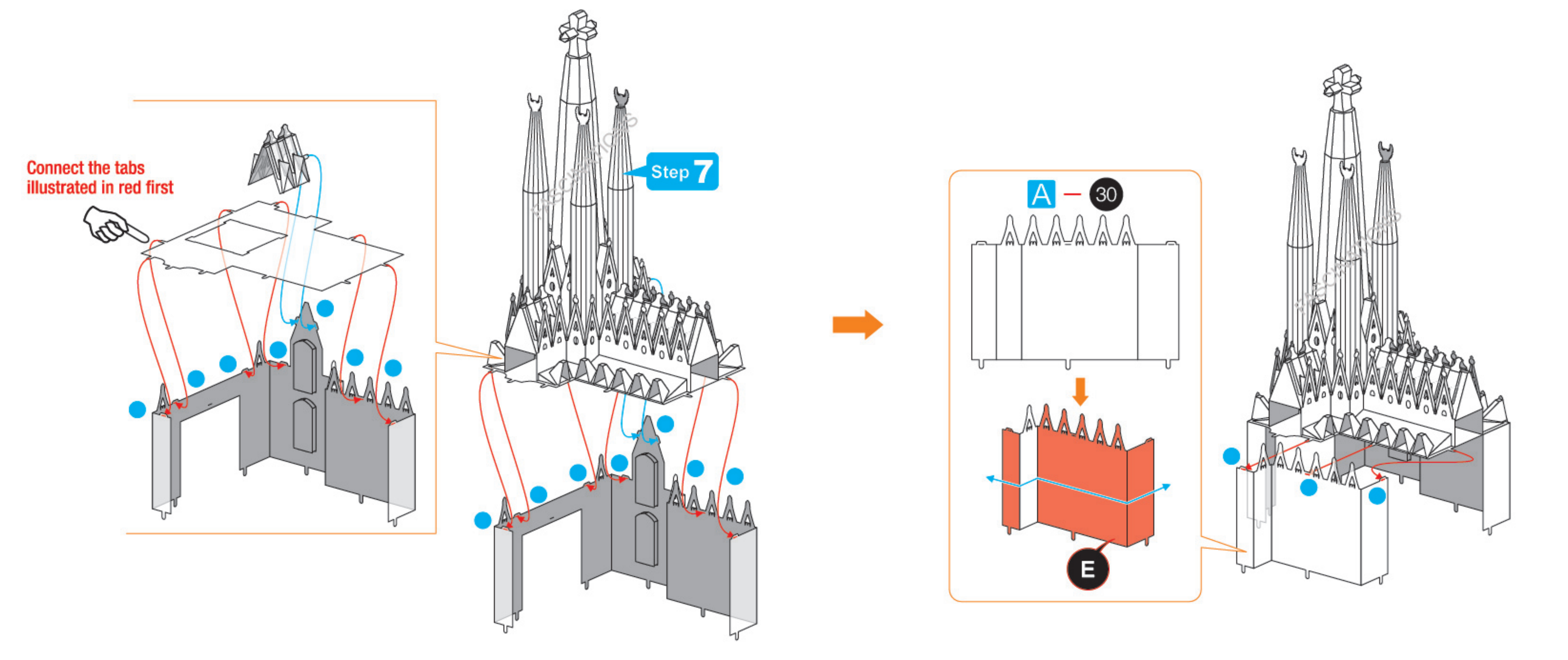
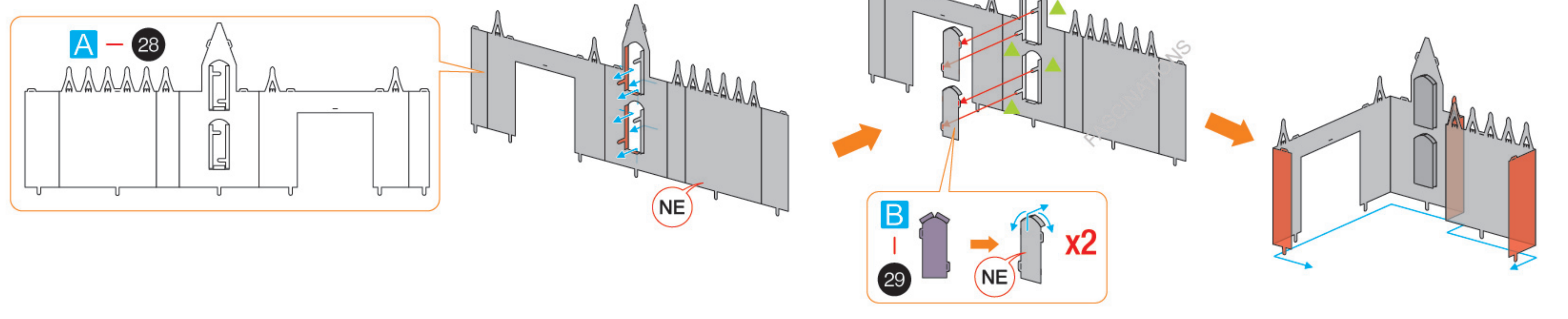

### Step 10

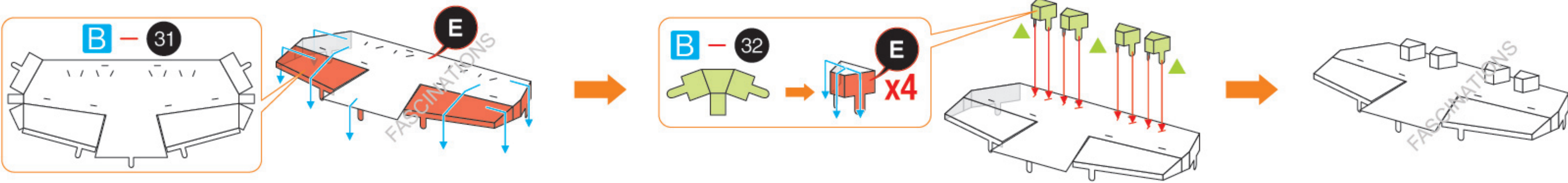

### Step 11

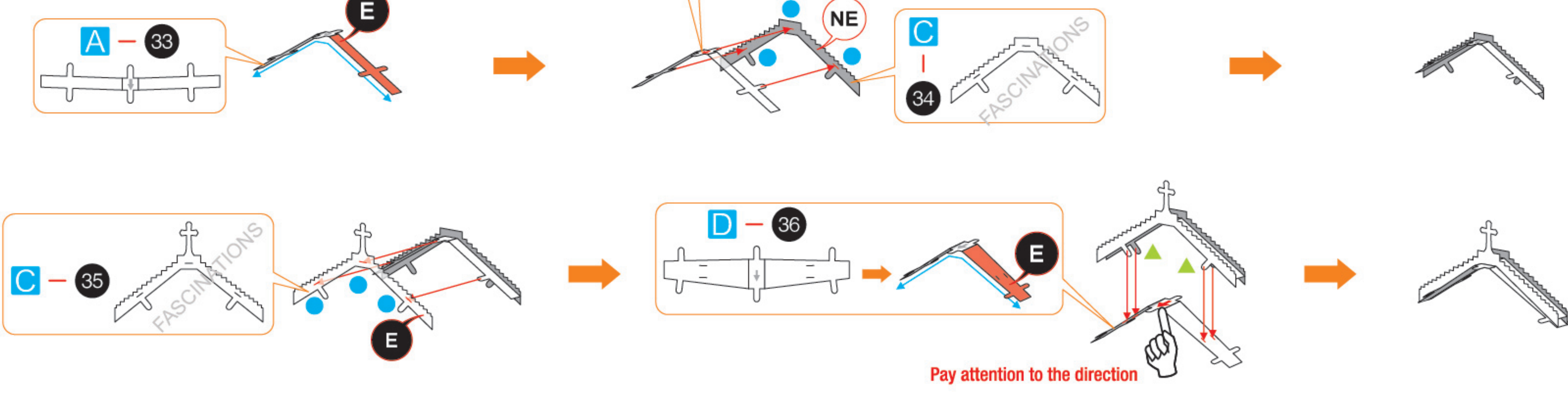

### Step 12

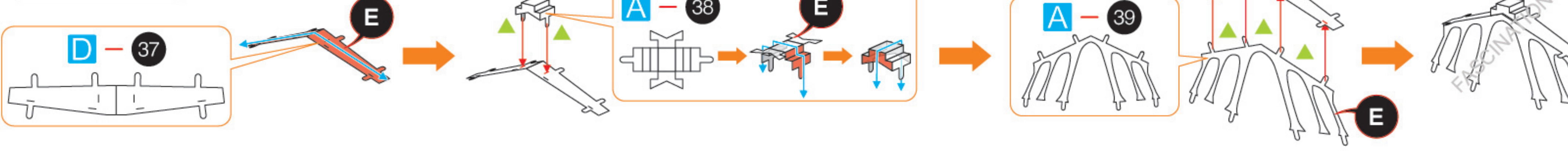

### Step 13

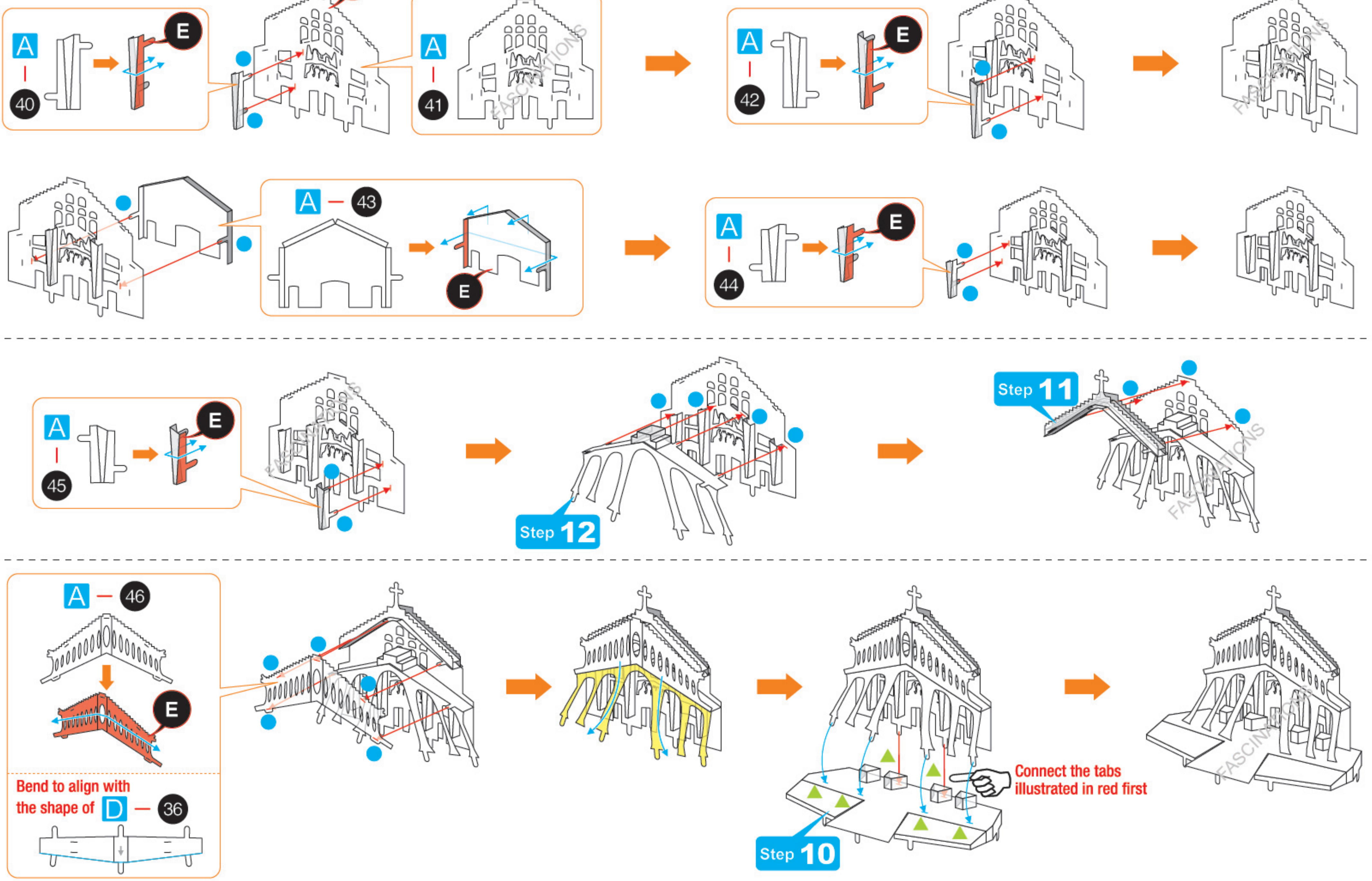

### Step 14

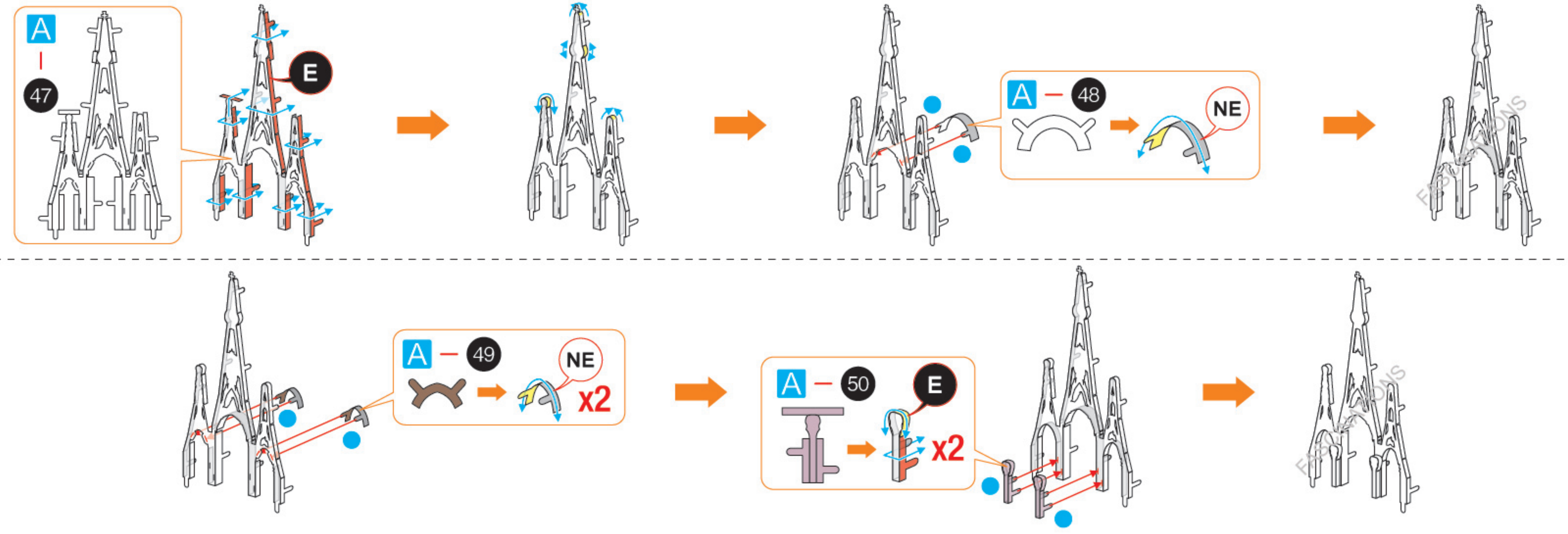

### Step 15

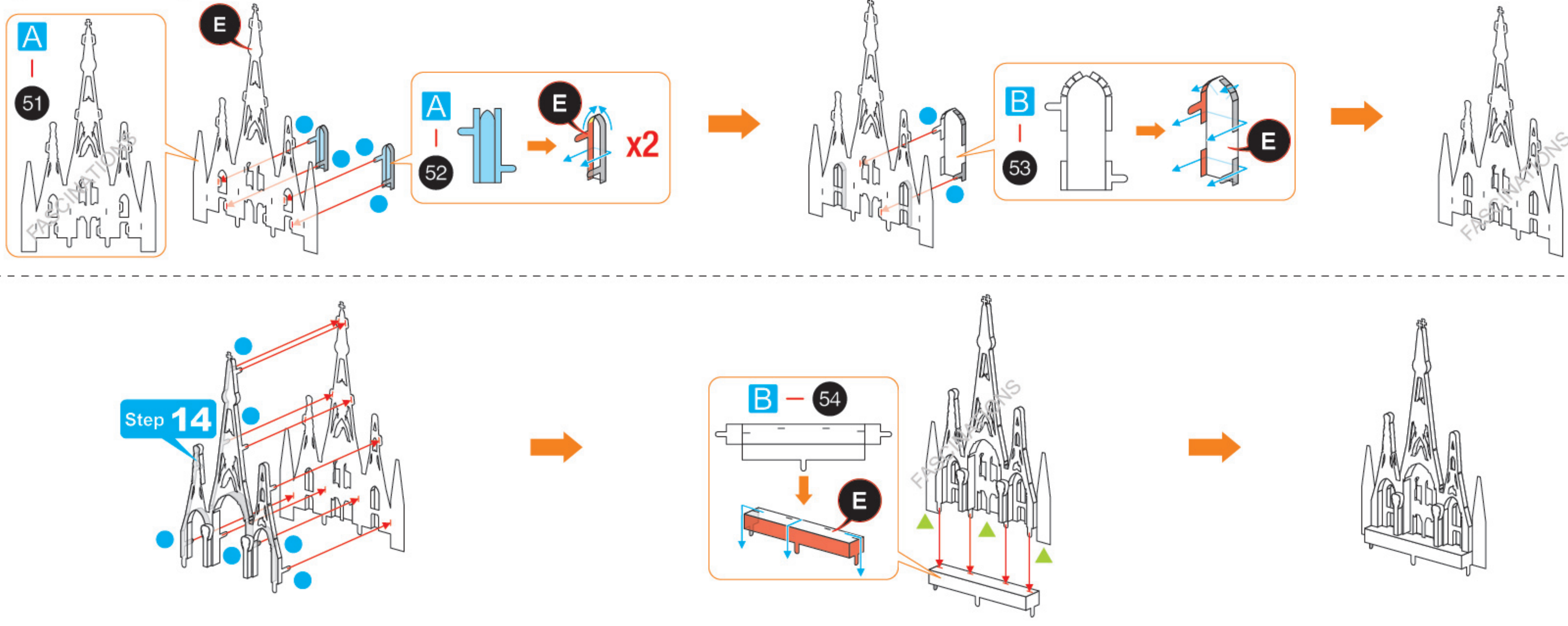

### Step 16

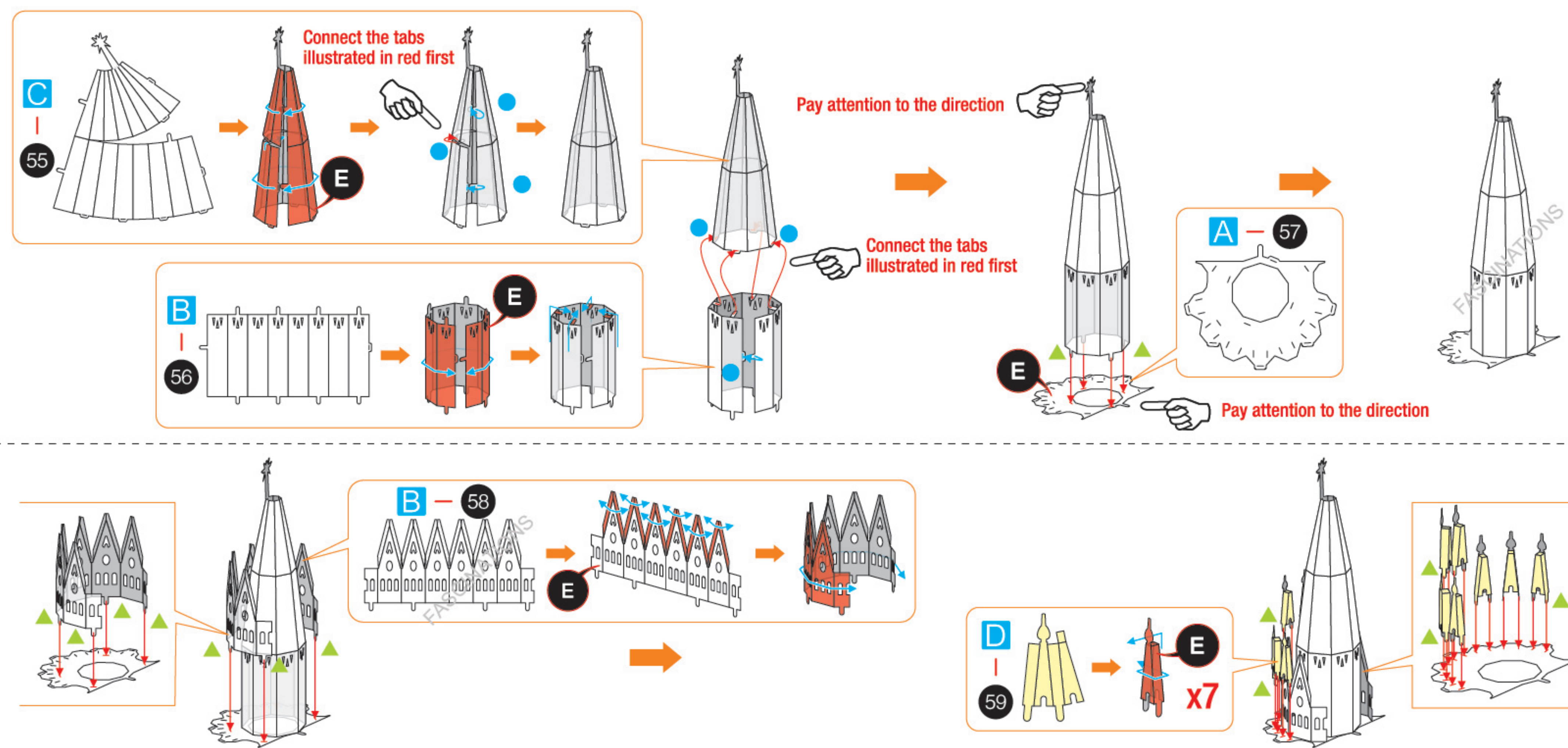

**Step 17**

**Step 18**

**Step 19**

**Step 20**

**Step 17**

**Step 18**

**Step 19**

**Step 20**

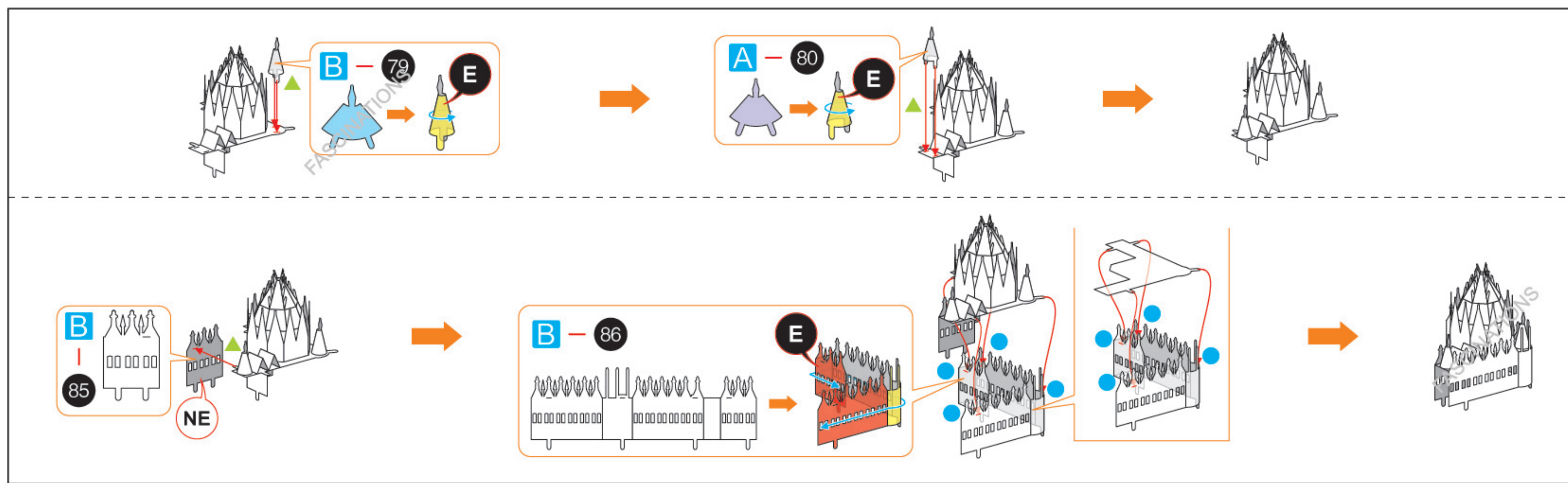

### Step 21

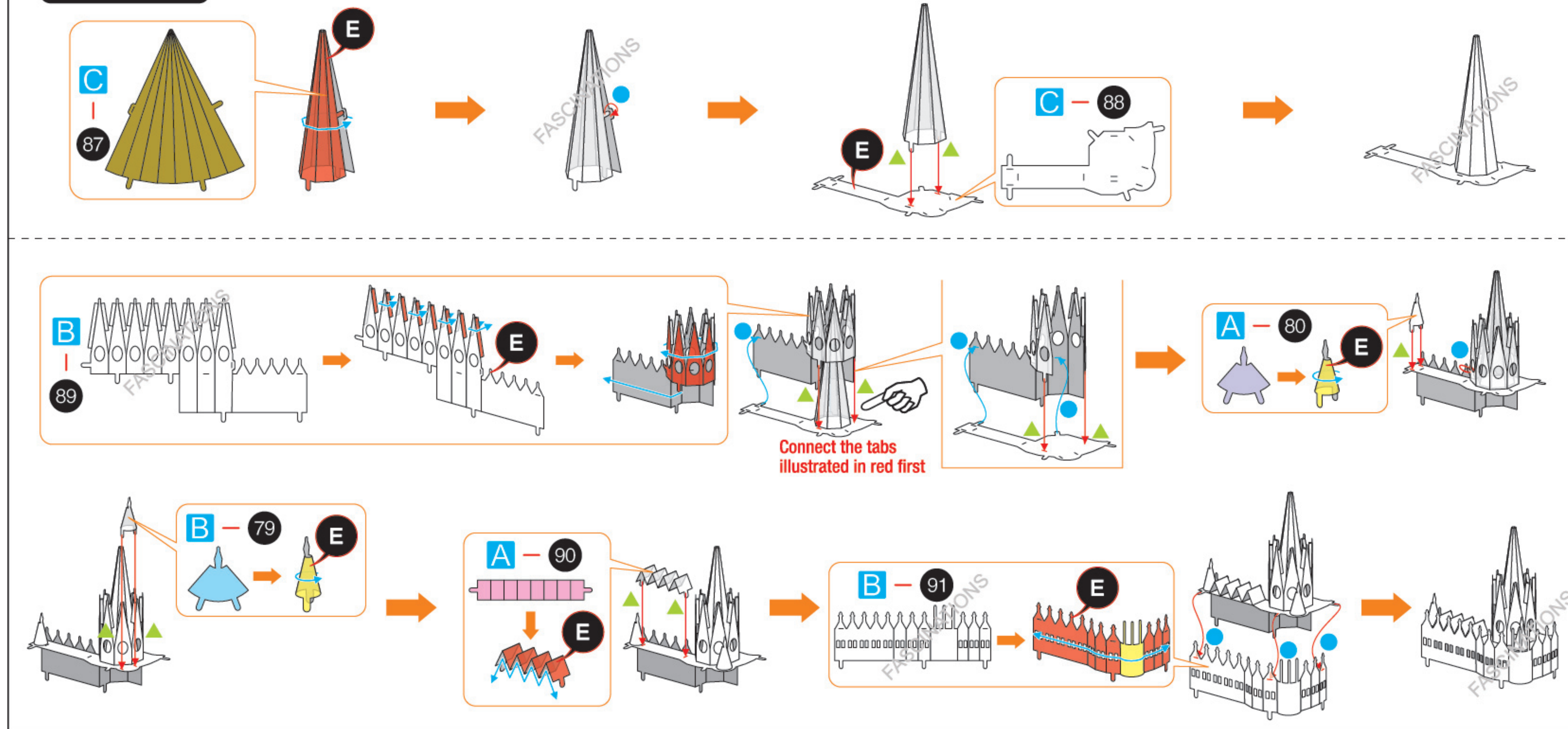

### Step 22

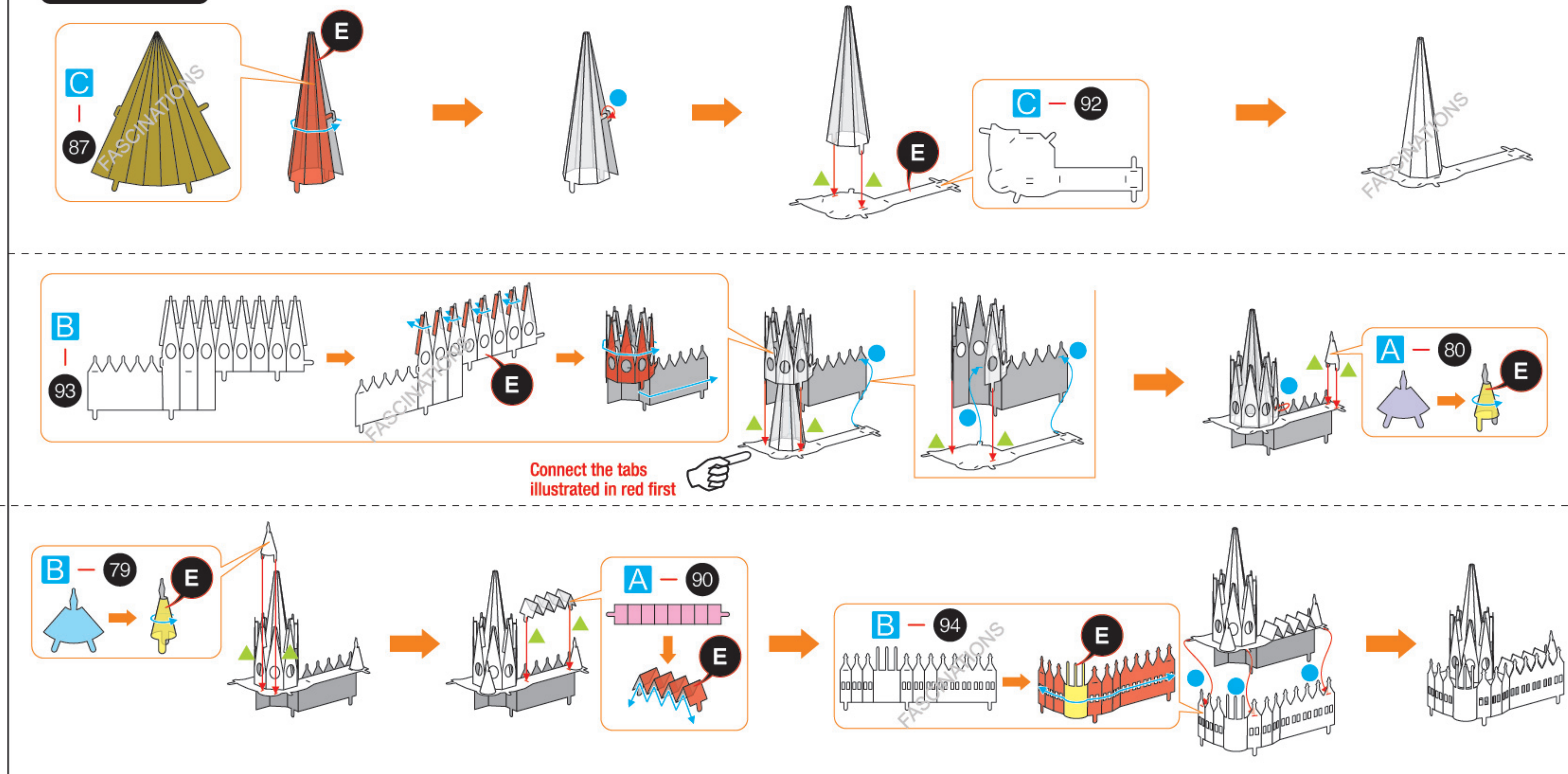

### Step 23

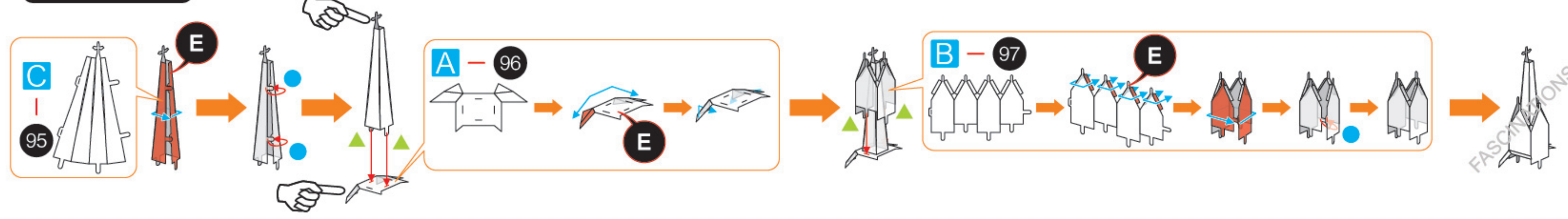

### Step 24

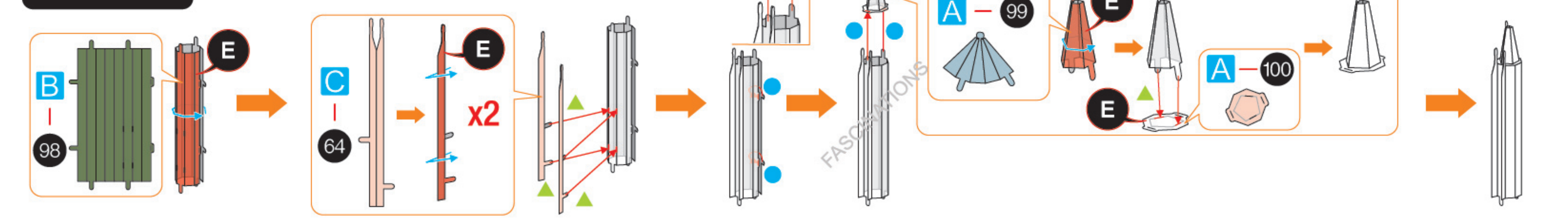

### Step 25

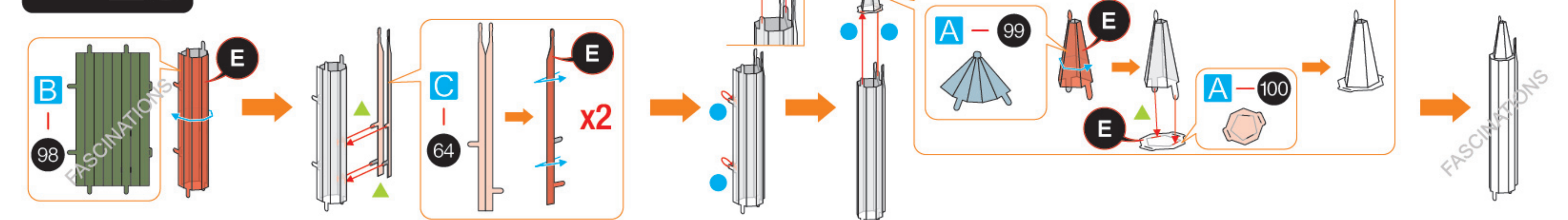

### Step 26

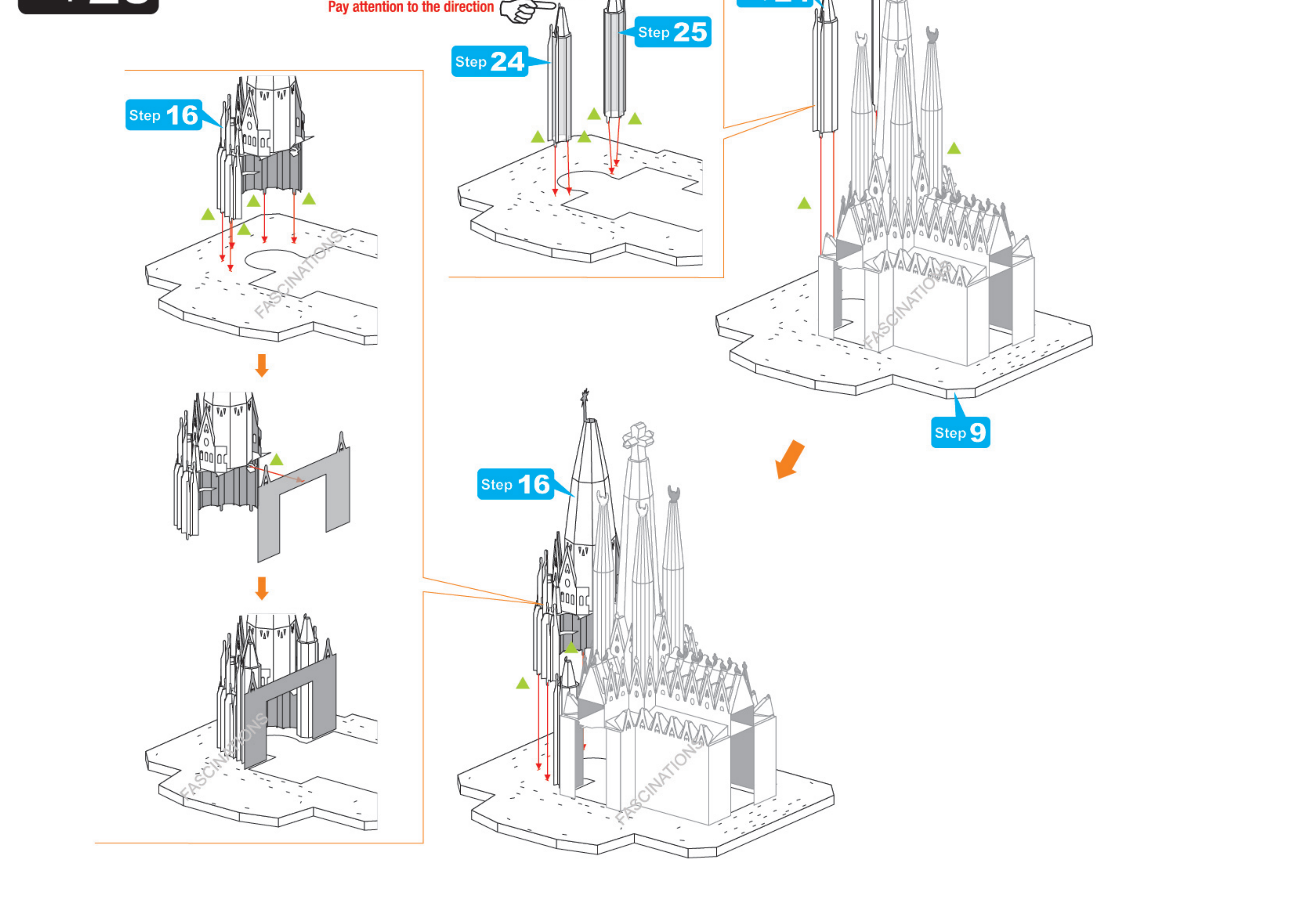

Step 19

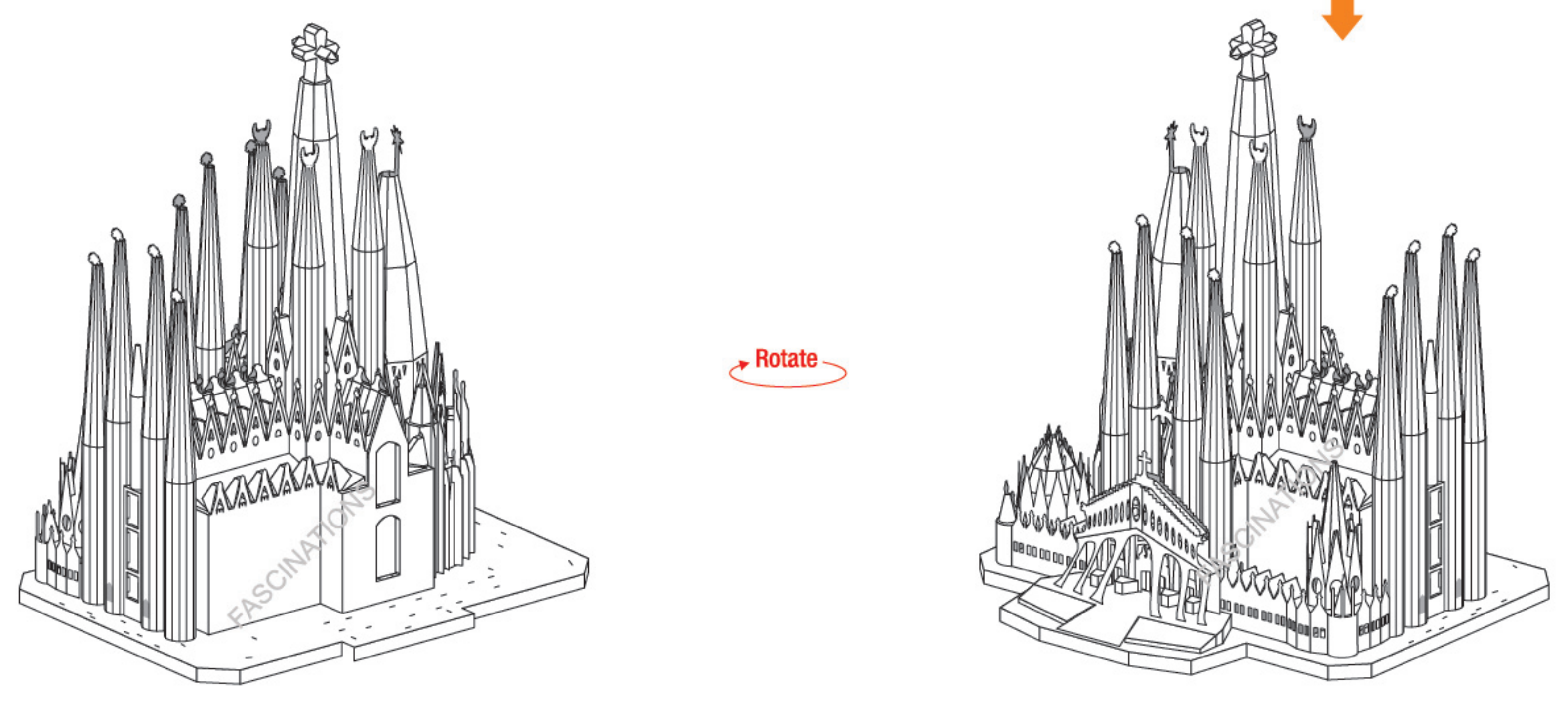
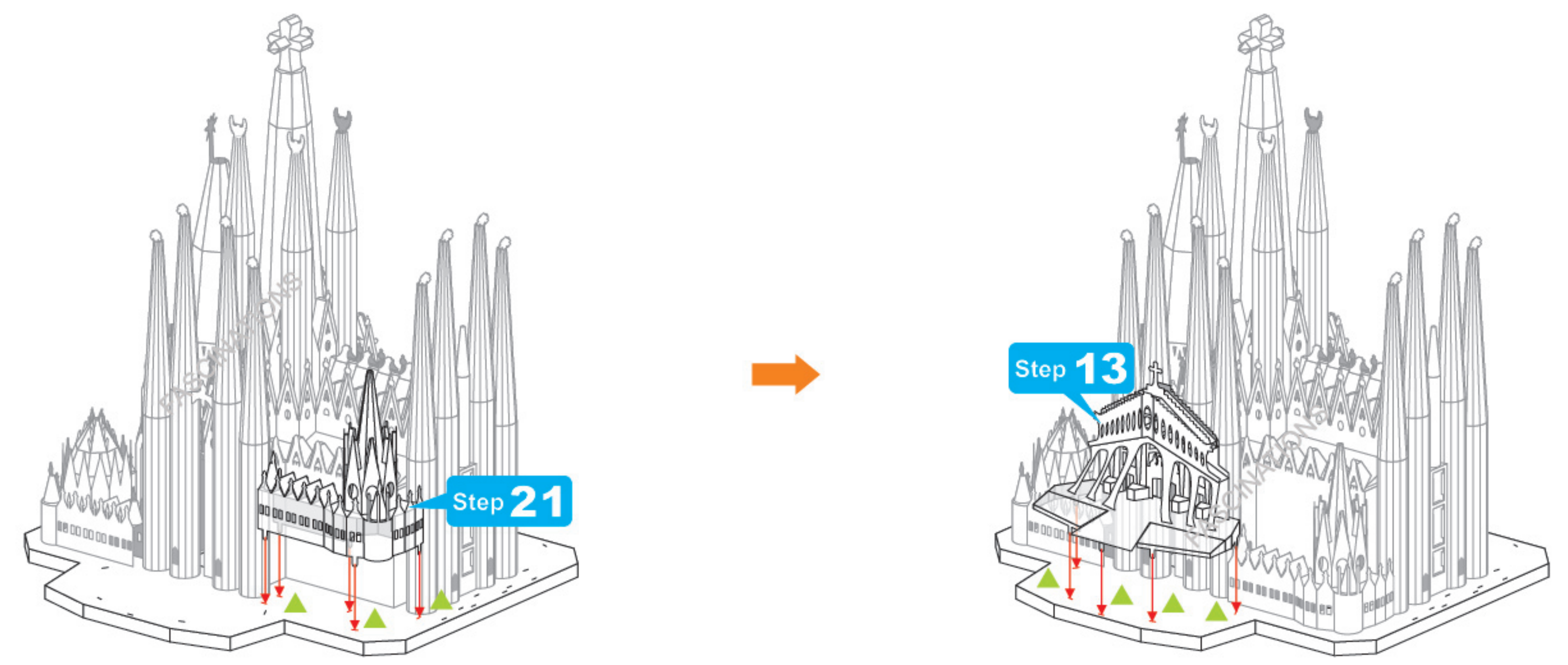
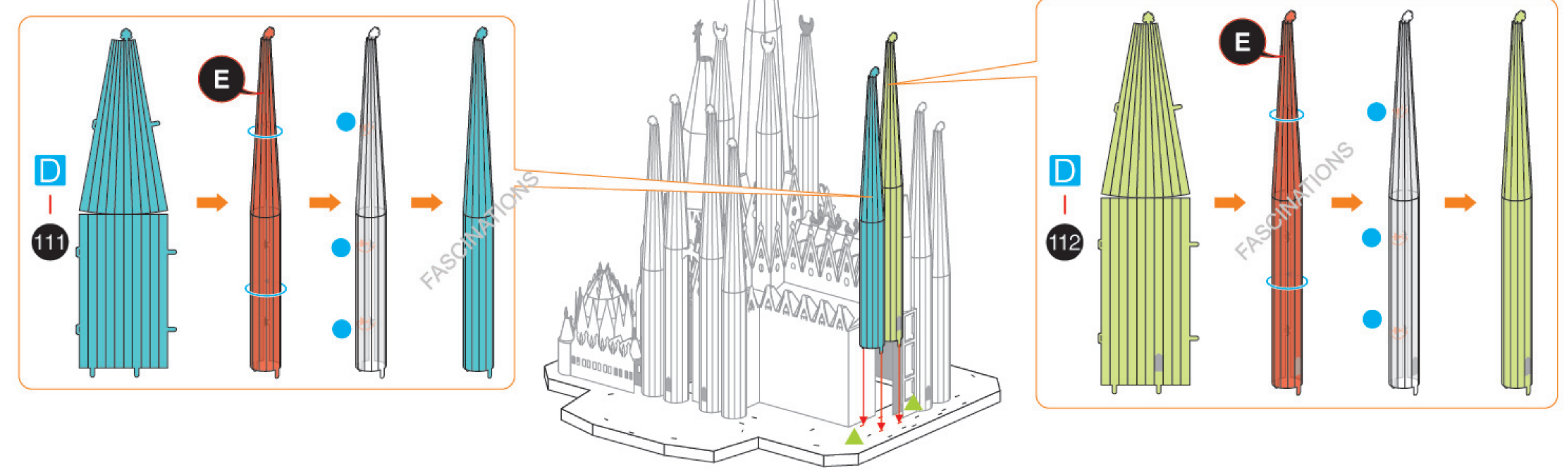
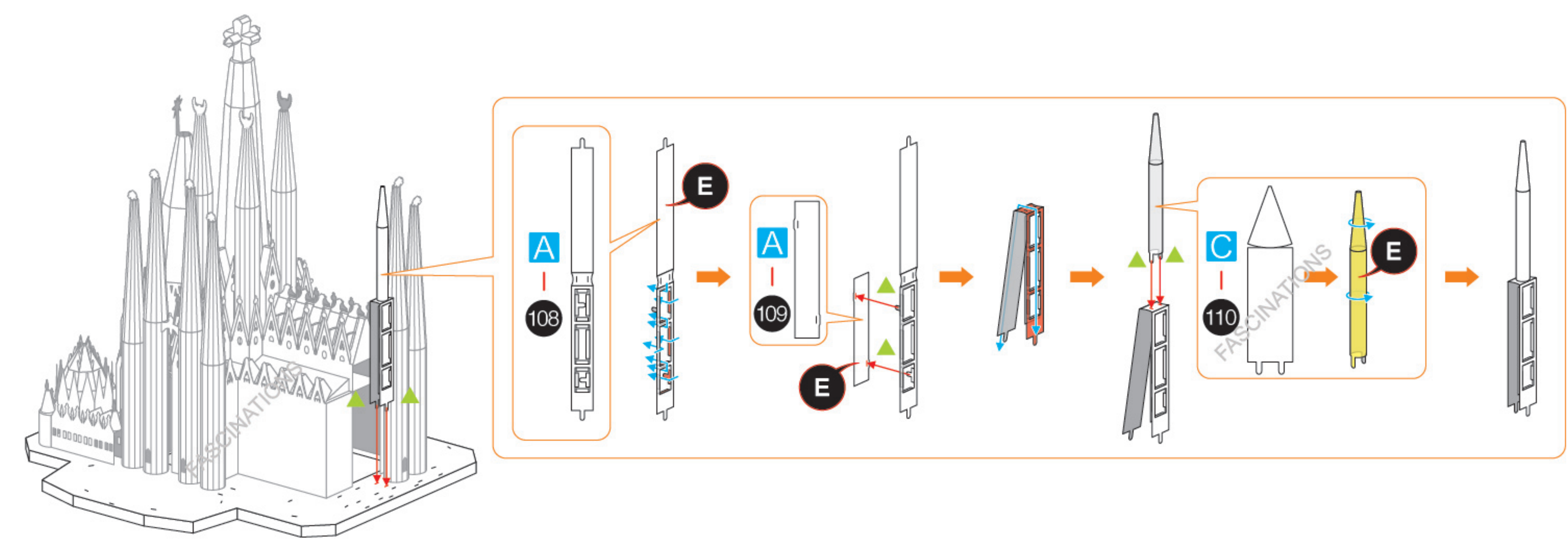
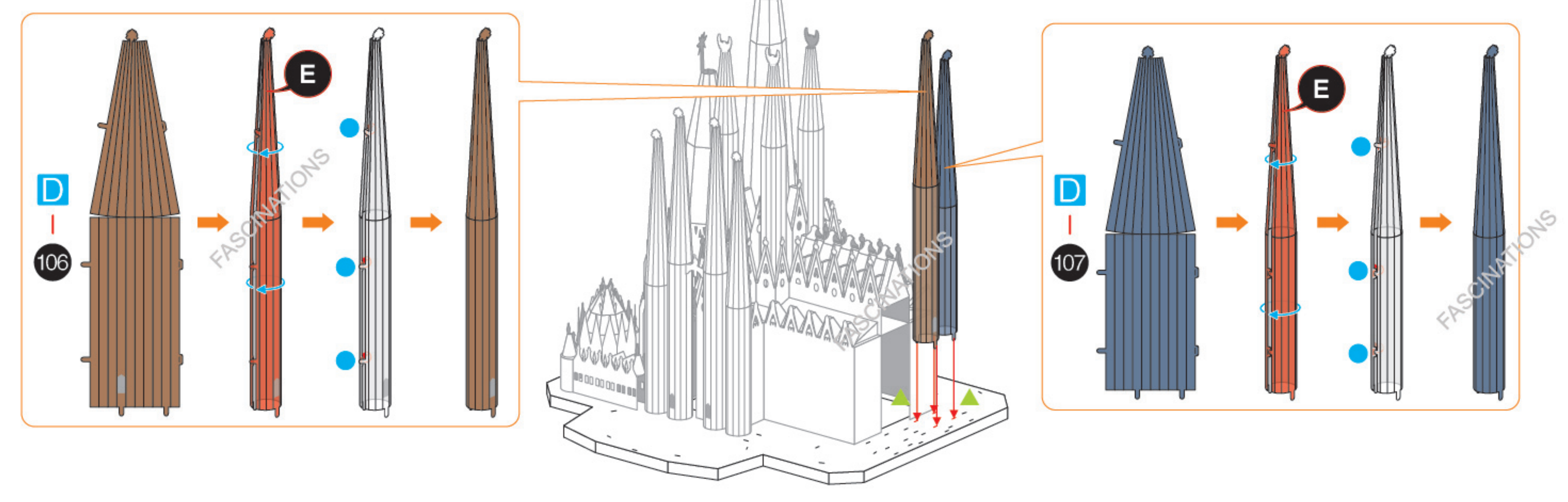
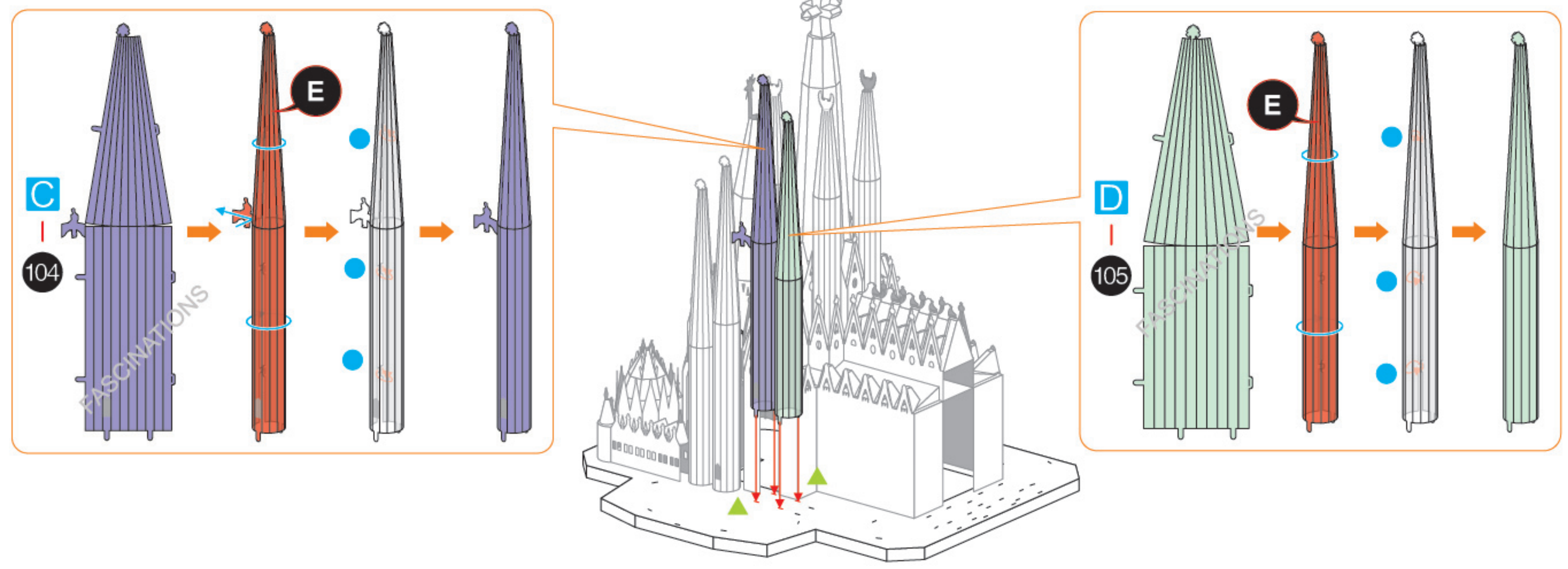
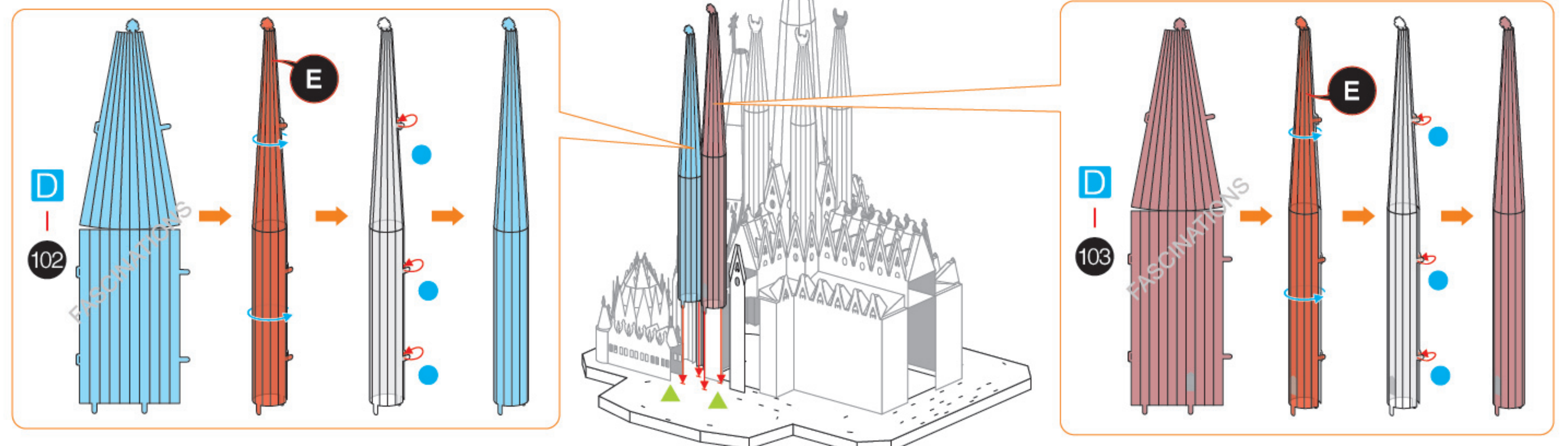
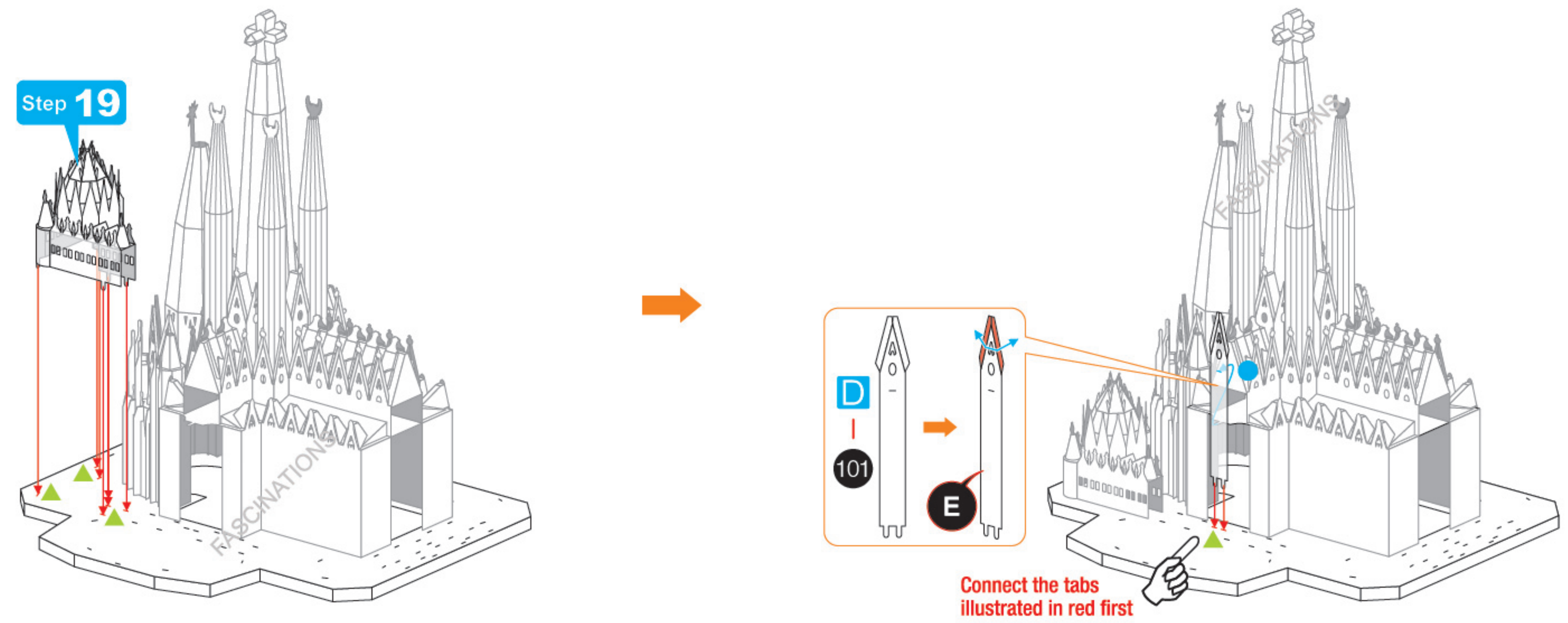

Step 27

