

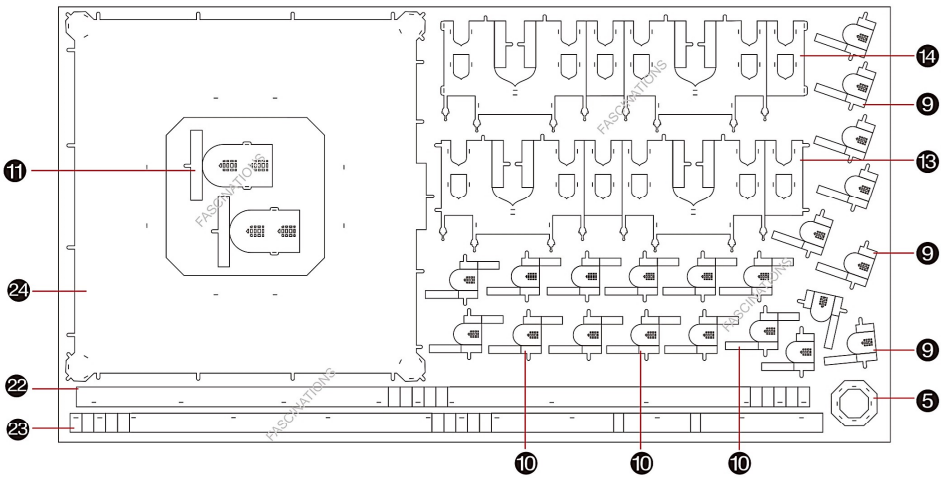

It is highly recommended that you visit www.metalearth.com/360/icx004 to see the completed model before assembling your own

3D METAL MODEL KITS

METAL SHEETS

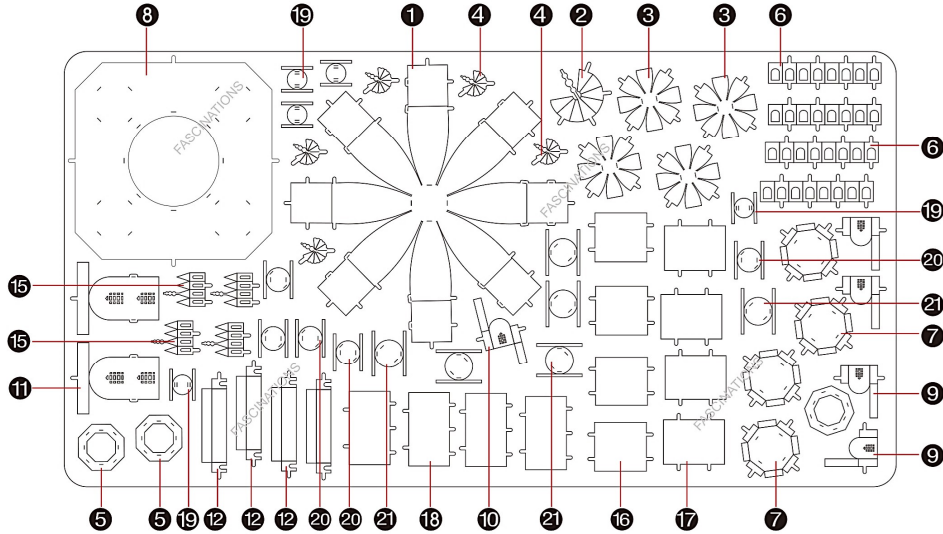

In order to avoid possible injury from sharp edges, please carefully discard the metal sheets after parts have been removed.

ICX004



Taj Mahal

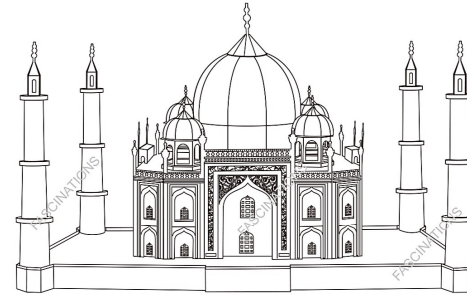

TO CREATE THE BEST CONNECTIONS

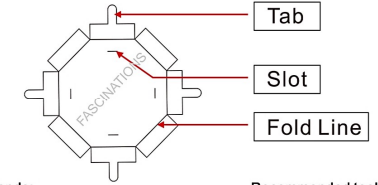

Legends:

- Engraved side
- Non-engraved side
- Attention point
- Insert tab and bend 90 degrees
- Insert tab and twist 90 degrees

Recommended tools:

-Wire cutters: helpful for taking parts from the metal sheets.



-Tweezers or needle nose pliers: helpful for folding parts, bending and twisting tabs.

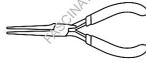

Assembly tip:

If needed, slightly twist tabs to hold parts together then untwist and bend them down for a nice finish

ASSEMBLY STEPS

Step 1

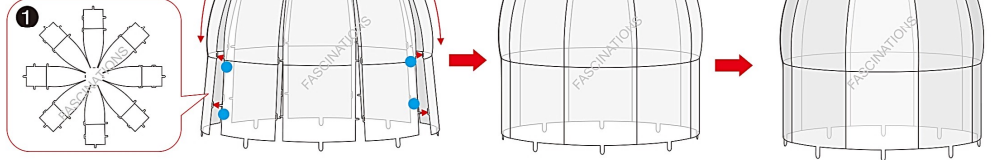

Step 2

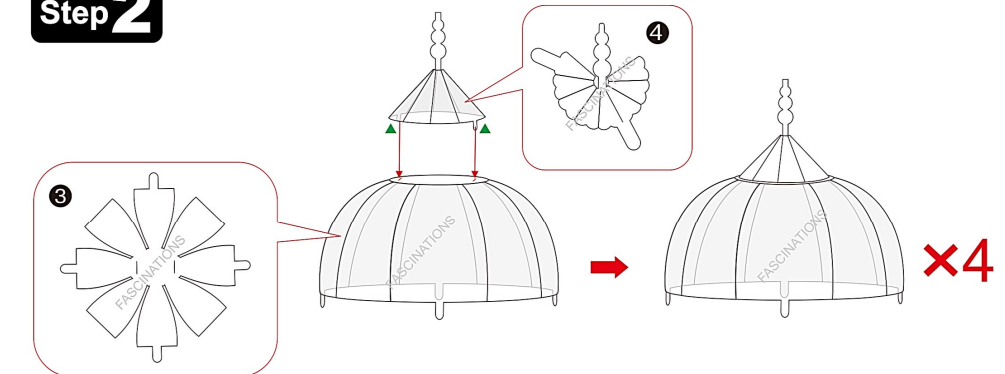

Step 3

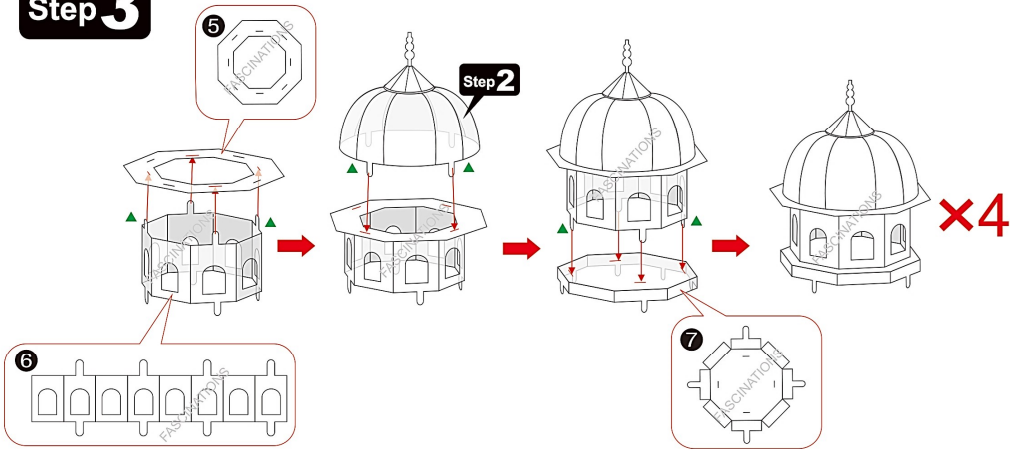

Step 4

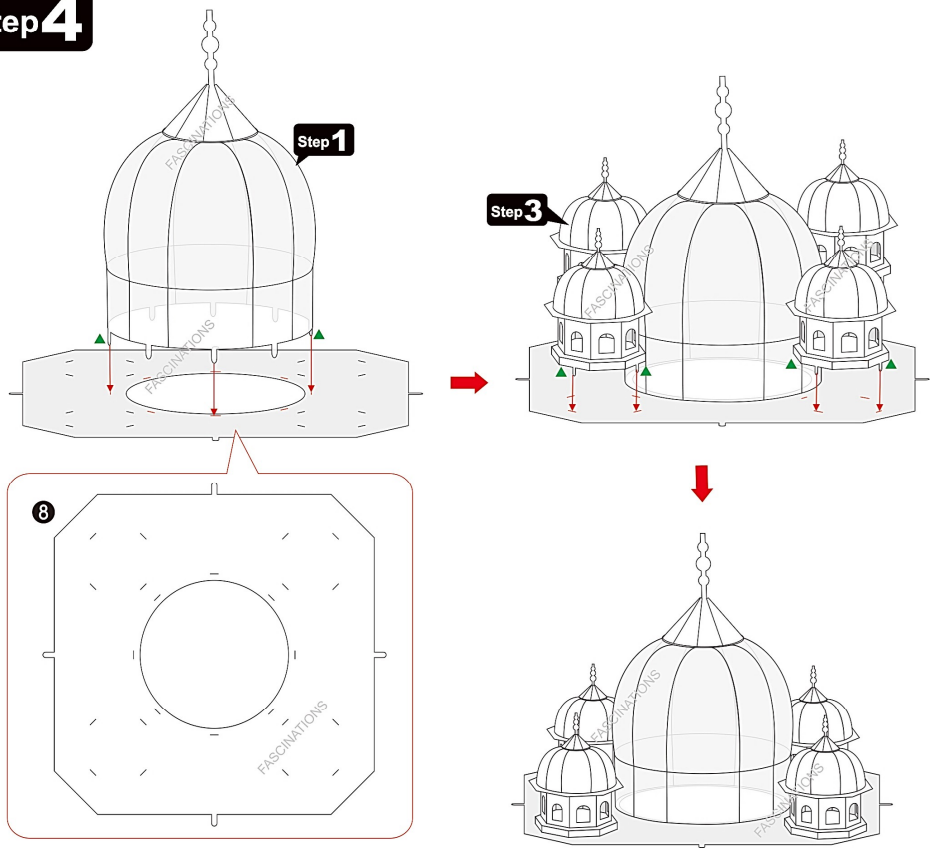

Step 5

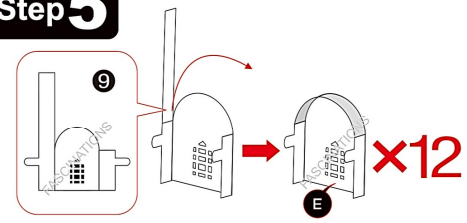

Step 6

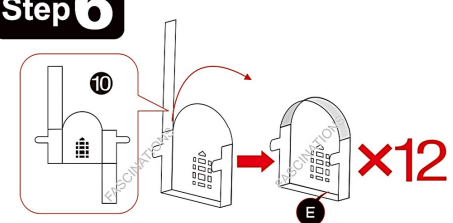

Step 7

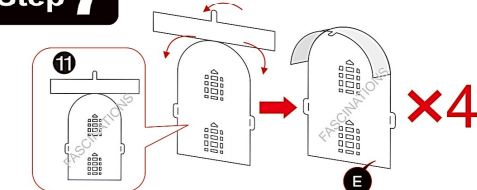

Step 8

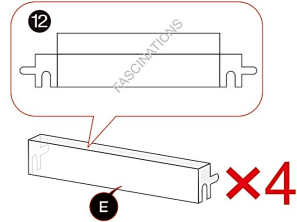

Step 9

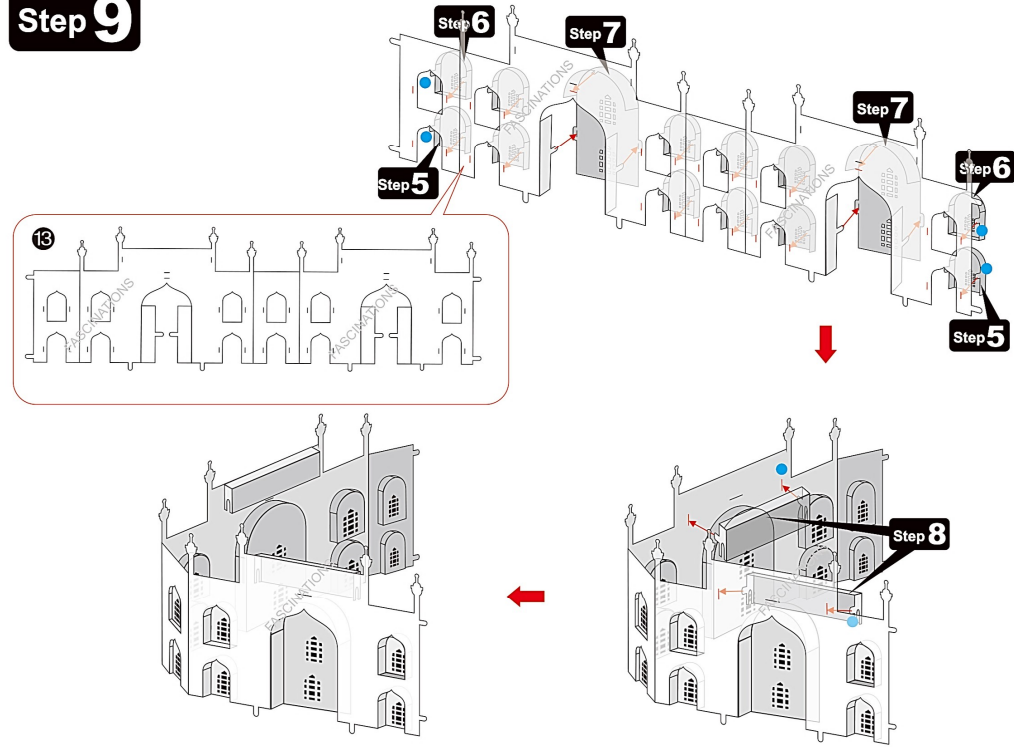

Step 10

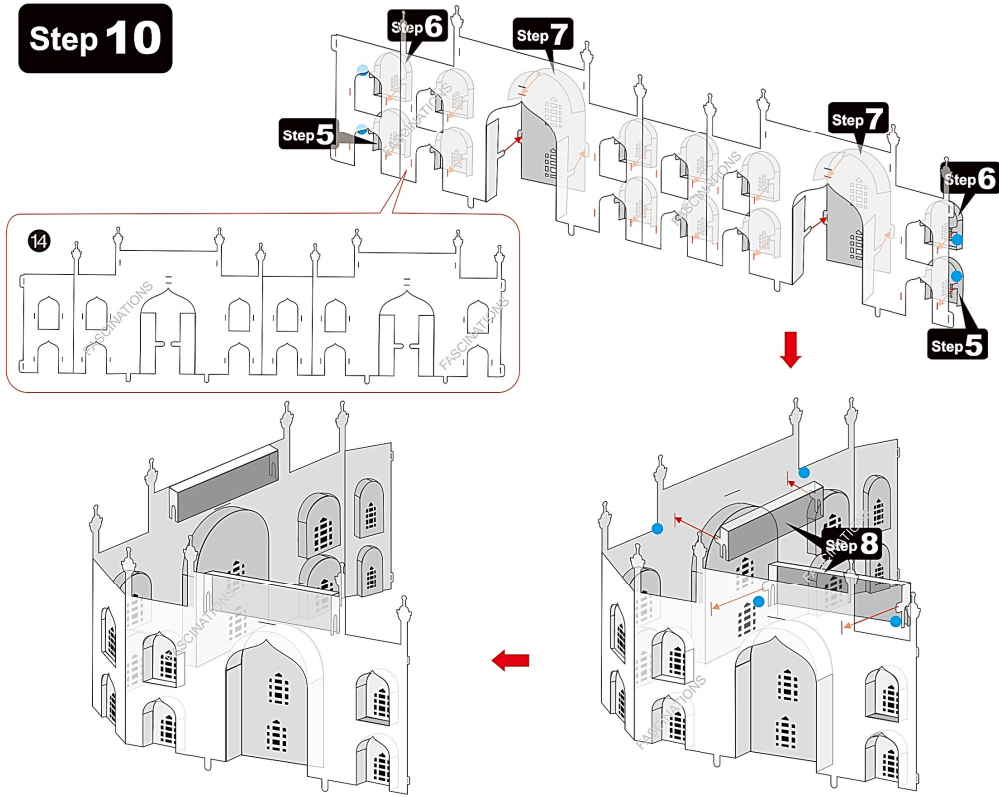

Step 11

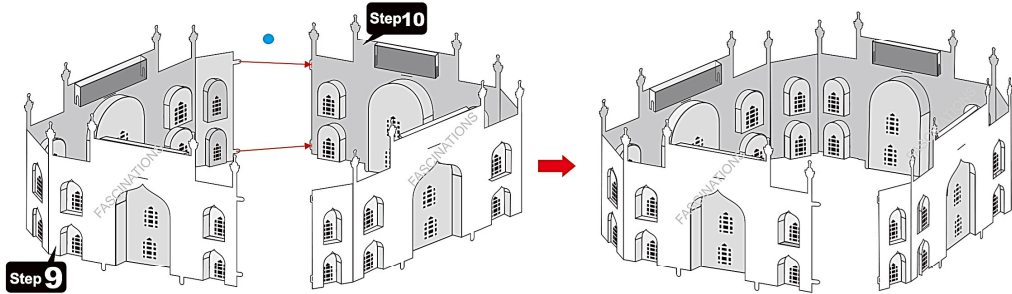

Step 12

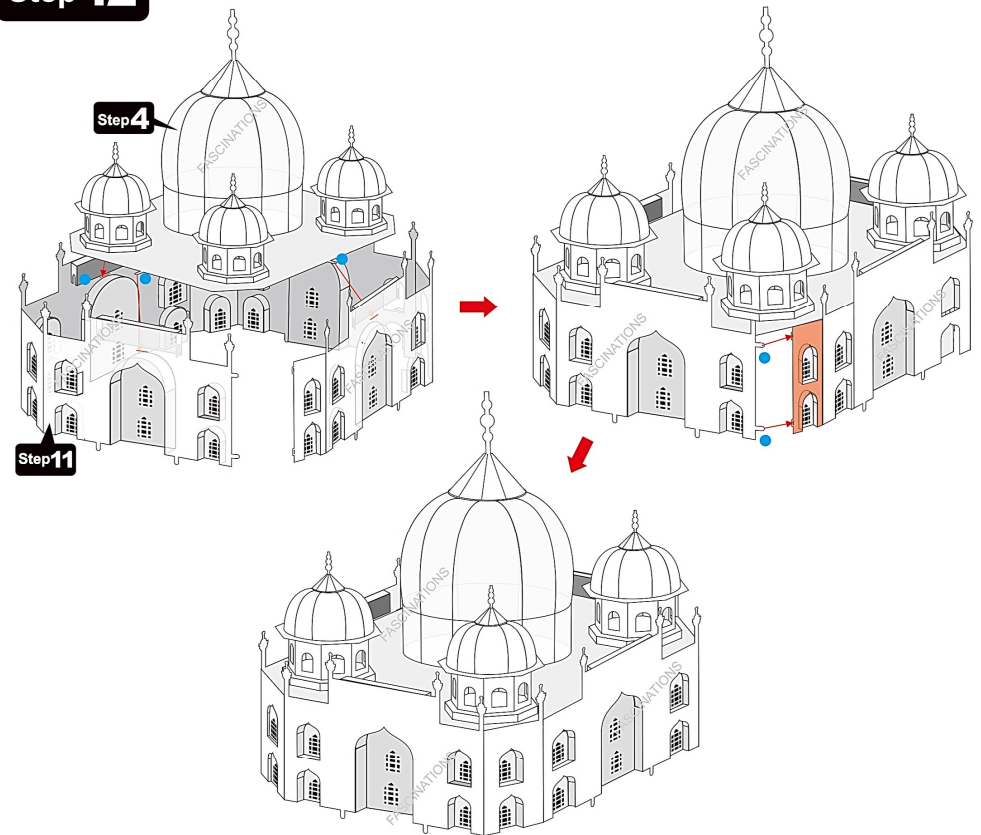

Step 13

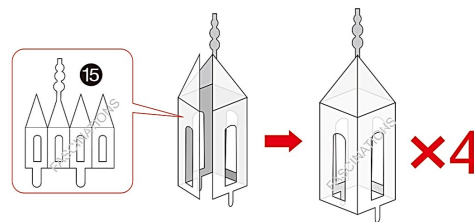

Step 14

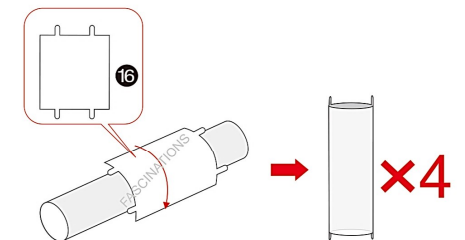

Step 15

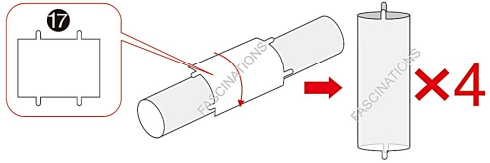

Step 16

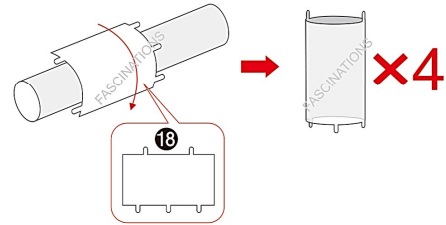

Step 17

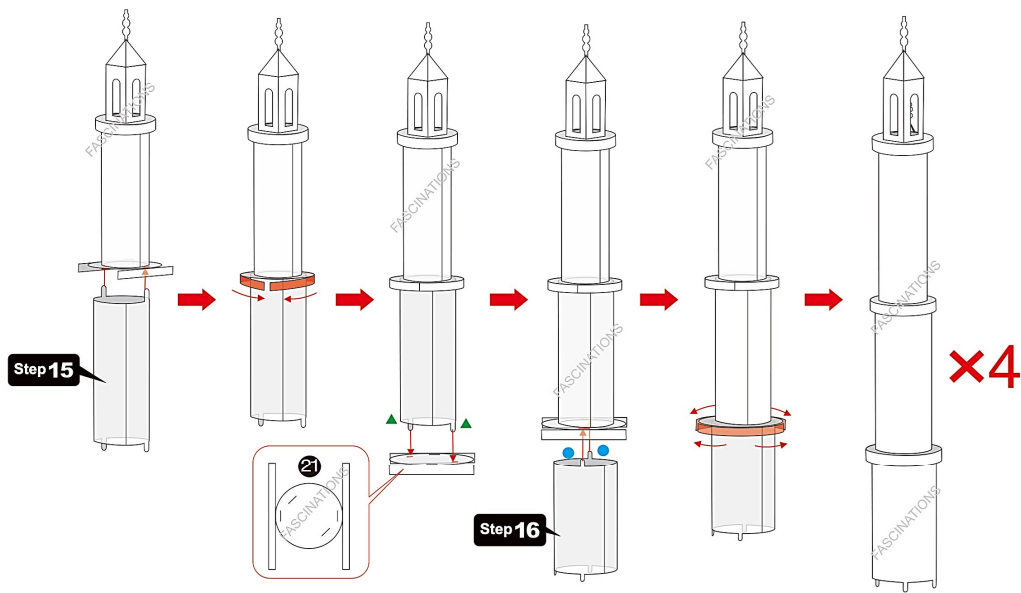
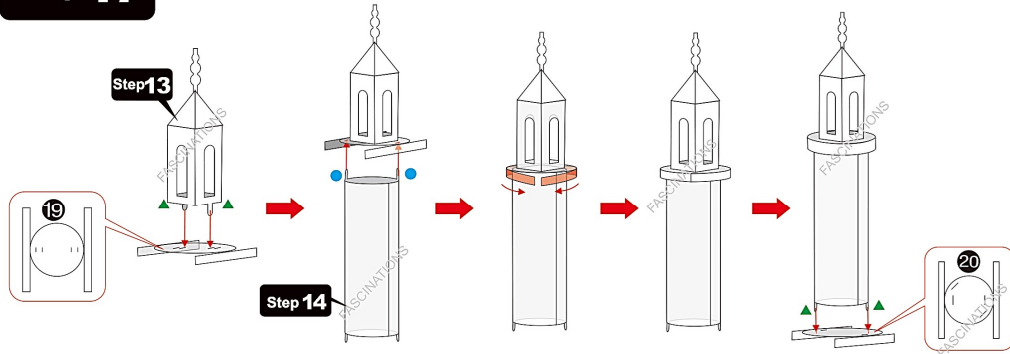

Step 18

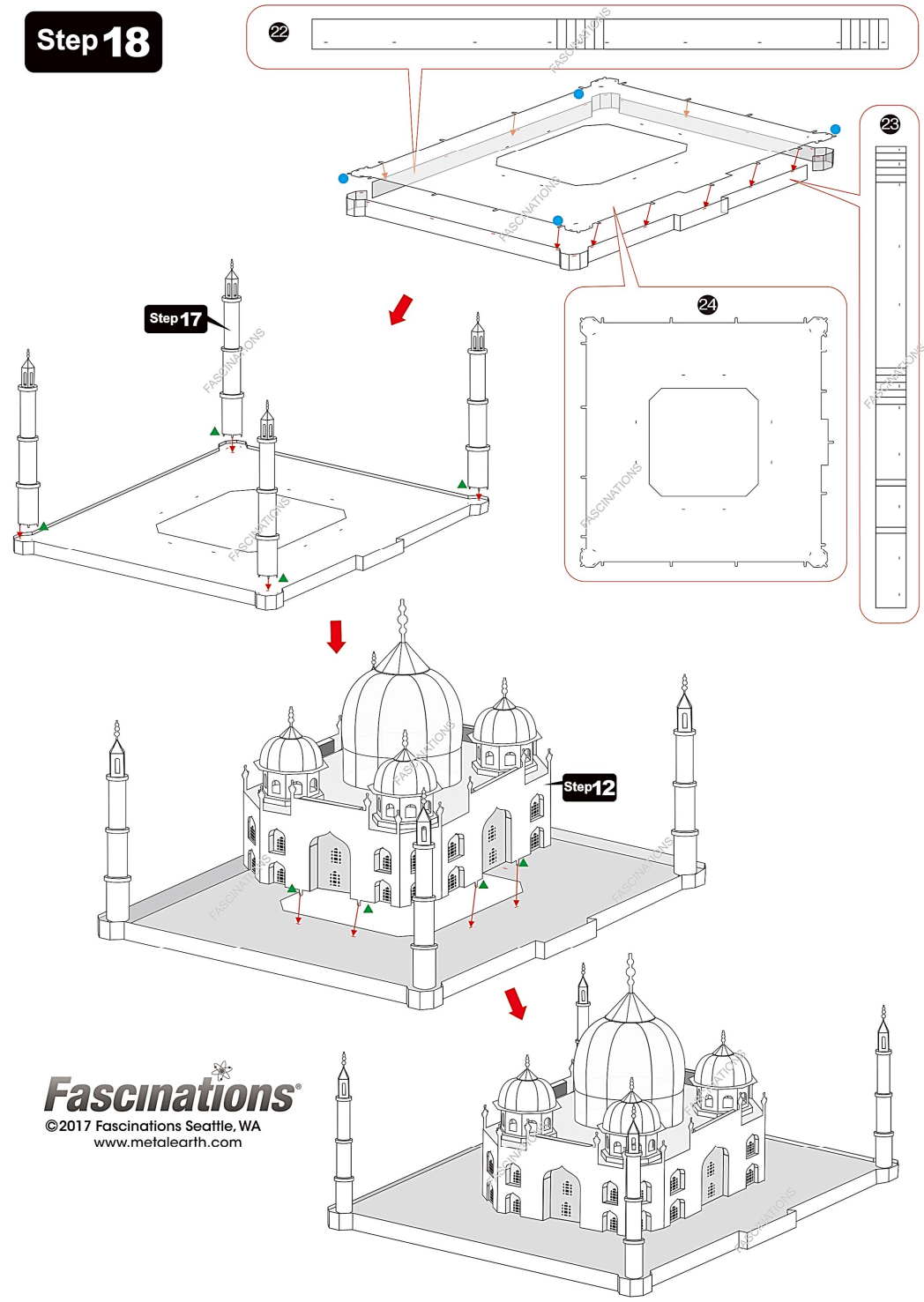

Fascinations®
 © 2017 Fascinations Seattle, WA
 www.metalearth.com