

METAL EARTH™

3D LASER CUT MODELS

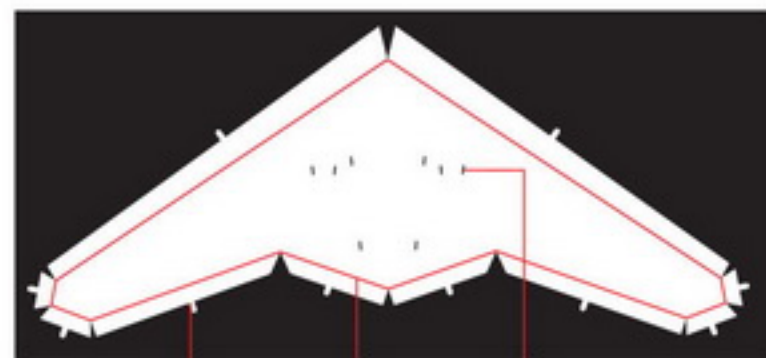

It is highly recommended that you visit www.fascinations.com/metalearth360/mms026 to see the completed model before assembling your own

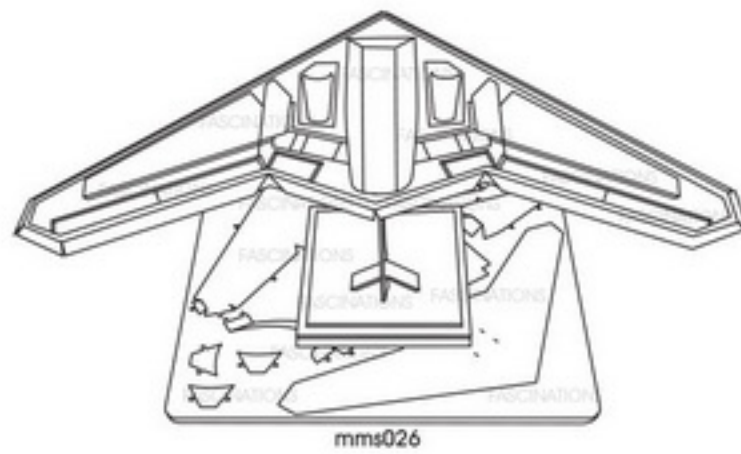

Insertion tabs are inserted and then folded

Fold lines can be seen as shown here

Insertion holes

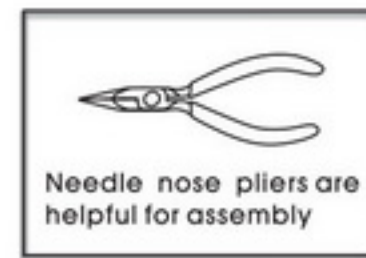

To create the best connections

Insert tab and bend 90 degrees for most visible areas

Insert tab and twist 90 degrees is best in some areas to ensure a tight connection

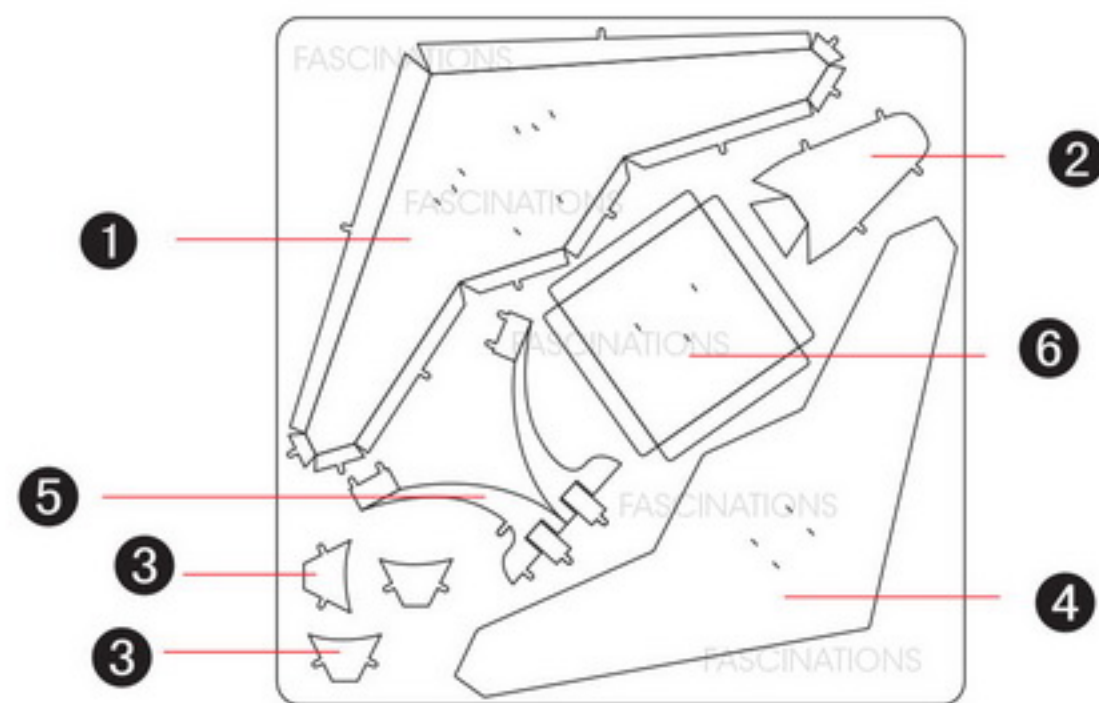
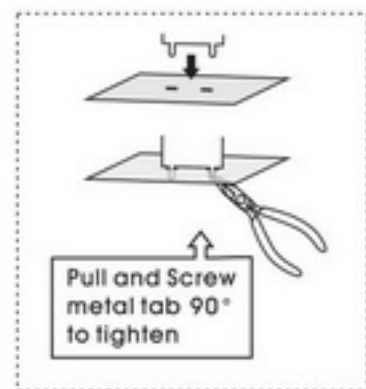

In order to avoid possible injury from sharp edges, please carefully discard the metal sheet after parts have been removed

Assembly Flow Chart

